



Soil Erosion and Sediment Control Pocket Guide

Office of Macomb County Public Works



Introduction

Perimeter
Control

Exposed Soils
and Slopes

Ditches

Inlets /
Outlets

Traps / Basins
Dewatering

Streams
Wetlands

Close-Out

Glossary

Important
Numbers

2014

The photo on the front cover shows the construction of a riparian buffer along the Lewis Drain. The channel of the Lewis Drain is protected by a wire-reinforced silt fence, seed, and an erosion control blanket.

The photo below shows the Lewis Drain Riparian Buffer Restoration project three weeks after the photo on the front cover. Notice how quickly the vegetation becomes established when proper soil erosion and sediment control measures are implemented.



Acknowledgements: This Pocket Guide was produced by the Macomb County Public Works Office and its consultant, Tetra Tech, Inc. Assistance provided by the Michigan Department of Environmental Quality. The development of this manual was made possible through funding provided by the U.S. Army Corps of Engineers.

CONTENTS

Introduction	ii
Chapter 1 Perimeter Control	
Diversion Berms and Ditches	2
Silt Fences and Other Barriers	5
Temporary Construction Access Road.....	5
Chapter 2 Exposed Soil and Slopes	
Surface Roughening	10
Seeding	11
Mulching	13
Silt Fences	15
Wattles	21
Erosion Control Blankets.....	22
Turf Reinforcement Mats	25
Polyacrylamides	27
Chapter 3 Ditches	
Erosion Control Blankets and Turf Reinforcement Mats	30
Check Dams	32
Riprap.....	34
Gabions.....	37
Chapter 4 Inlet and Outlet Protection	
Inlet Filters	42
Outlet Pipe Riprap Protection	52
Detention Basin Outlet Filter	54
Chapter 5 Sediment Traps, Basins, and Dewatering	
Sediment Traps and Basins	58
Pump Filter Bags	62
Chapter 6 Stream and Wetland Protection	
Permits.....	68
Stream Crossings.....	68
Vegetated Buffers.....	68
Turbidity Barriers	70
Chapter 7 Final Stabilization for Close-Out	74
Glossary	75
Important Numbers	80

Introduction

Perimeter Control

Exposed Soils and Slopes

Ditches

Inlets / Outlets

Traps / Basins Dewatering

Streams Wetlands

Close-Out

Glossary

Important Numbers

INTRODUCTION

What is soil erosion?

Soil erosion is the process by which land surface is worn away by wind, water, ice, or gravity. This process may be accelerated by human impacts due to farming or **construction activities**. It is estimated that from all sources of erosion, 4.5 billion tons of **sediment** pollute U.S. rivers each year. Seventy percent of the sediment generated is thought to be the result of construction and farming activities. (MDEQ SESC Training Manual).

Why is managing soil erosion important?

The lack of soil erosion and sediment control may result in the loss of **topsoil** on site; increased peak flows and flooding; clogged ditches and culverts; muddy lakes and streams; damaged plant, animal, and aquatic habitats; increased cost for water treatment; and structural damage to roads, bridges, and other structures.

There are several easy site management techniques that can be implemented on construction sites to minimize the potential of soil erosion and the risk of sediment leaving the site. However, these techniques are only effective when soil erosion and sediment control measures are properly installed and maintained and will vary based on site conditions (e.g., soils, slopes, area disturbed). The purpose of this pocket guide is to provide the user with the proper installation techniques to manage and reduce soil erosion and sediment impacts from construction sites.



Chapter 1 Perimeter Control

- Diversion Berms and Ditches..... 2
- Silt Fences and Other Barriers 5
- Temporary Construction Access Road 6



Construction access drives are required before clearing and grading work begins. Access drives must be maintained until the site is stabilized. Inspections should note whether mud is being tracked onto paved roads. This photo shows an example of a construction access drive that is not properly stabilized.

PERIMETER CONTROL

Perimeter controls are used to control sediment-laden runoff from leaving a construction site and define the construction perimeter and/or sensitive areas. It is important that perimeter controls are in place before any earthmoving activities begin.

Diversion Berms and Ditches

A **diversion berm** is a long, mounded “collar” of compacted soil located uphill from the excavated area. The berm is designed to intercept overland runoff and direct it around the construction site. This prevents “clean” water from mixing with soil from the construction site. **Diversion ditches** are similar to diversion berms. They are designed to intercept and divert upland runoff around bare soil areas. Ditches are cut above cleared or fill areas and designed with a gentle slope to carry water away from the work area.



Diversion channels should be stabilized

General Installation

- Diversion berms and ditches are installed and stabilized prior to other land disturbing activities.
- Diversion berms and ditches are designed for the 10-year, 24-hour peak flow.
- Diversion berms must have a minimum height of 18 inches, side slopes of 2H:1V or flatter, and a minimum base width of 4.5 feet.
- Diversion ditches have a minimum depth of 12 inches with side slopes of 2H:1V or flatter.
- Diversion berms and ditches must be stabilized prior to being placed into operation to prevent erosion.

- ❑ Diversion berms must not be used in high-traffic areas where they may be damaged.
- ❑ Diversion berms must be constructed parallel to the contour.
- ❑ Diversion berms must not be constructed out of sand, gravel, or debris-laden material.

Common Mistakes

- ❑ Cutting diversion ditches that are too steep. The slope of the diversion ditch should be sufficient to promote positive drainage but not too steep to cause erosion.
- ❑ Failing to temporarily divert the runoff until the seeded areas are permanently stabilized. Concentrated flows should be directed to areas with established vegetation.

Inspection and Maintenance

- ❑ Inspect the diversion berms and diversion ditches for signs of erosion. Immediately repair any problems that are found.
- ❑ Ensure runoff is being captured by the diversion and not flowing around it.
- ❑ If during storm events, berms are over topped or ditches are overflowing, the design and construction should be reviewed.
- ❑ Inspect the discharge point and ensure that the sediment being carried by the discharge is properly contained.
- ❑ Watch for concentrated flows when the berm directs water to one area.

Tips

- ❑ Diversion ditches should discharge to flat vegetated areas to promote dispersal and infiltration.
- ❑ Diversion ditches with slopes less than 5% may be heavily seeded, mulched, and maintained without additional protection if stabilized quickly after construction.
- ❑ Diversion ditches with slopes of 5% or more need erosion control blankets, turf mats, or rip-rap.

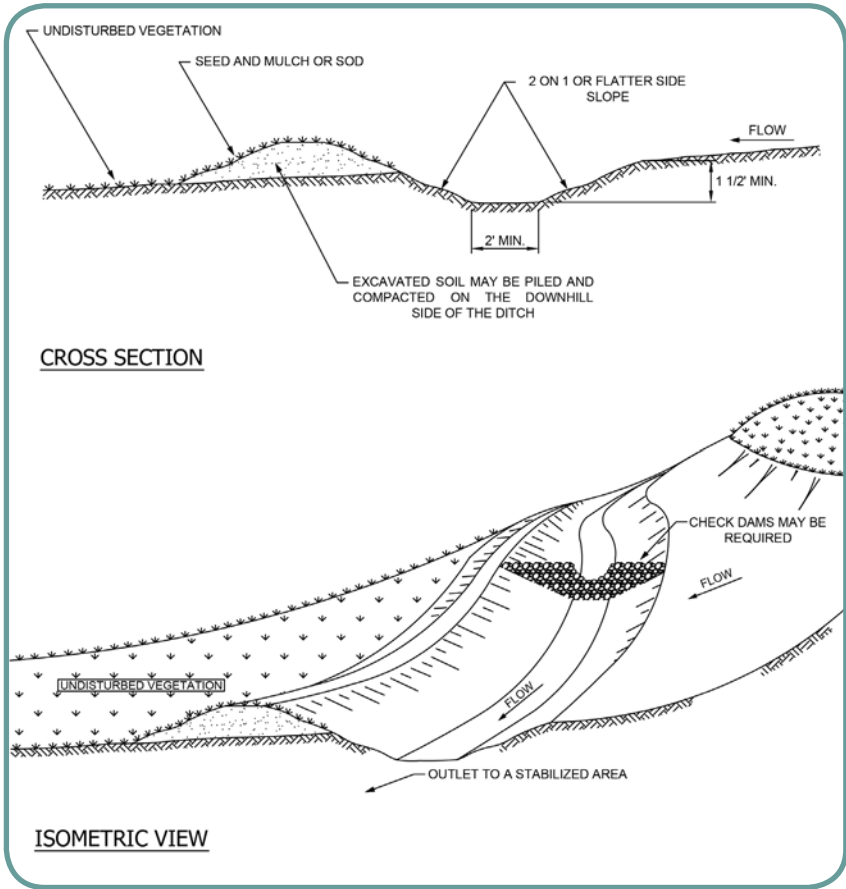

Figure 1-1 Diversion Ditch

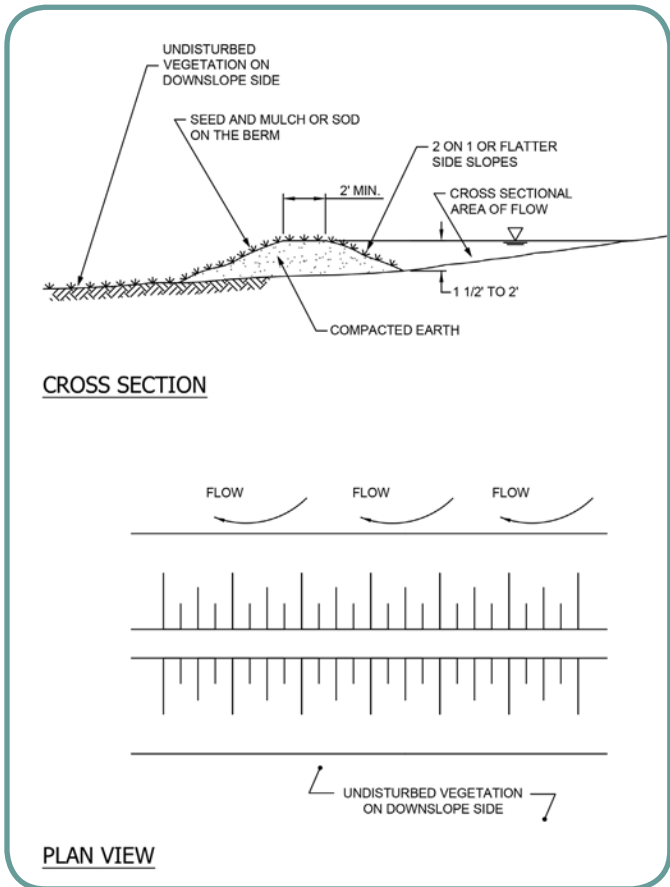

Figure 1-2 Diversion Berm

Silt Fences and Other Barriers

Silt fences are commonly used as temporary perimeter controls around construction sites where the soil will be disturbed. The true purpose of silt fence is to remove sediment from runoff by slowing down the flow. This causes the sediment to drop out of suspension. The silt fence also acts as a filter, catching sediment, as the water passes through.

Silt fence may be used as a temporary perimeter control; please refer to Chapter 2 for detailed information on proper installation and maintenance. Other barriers or devices may be used for perimeter control, as approved by Macomb County.

Temporary Construction Access Road

Mud tracked onto paved roads is the number one complaint from citizens regarding construction site operations. The purpose of a temporary construction access road is to minimize the amount of sediment leaving the area as mud and/or dirt attaches to vehicle tires. As a vehicle drives over the construction access road, it removes mud and sediment from the tires and reduces tracking from the site.

General Installation

- A geotextile fabric barrier must be placed on the ground, prior to the aggregate.
- The aggregate layer must be at least 6 inches thick using 1- to 3-inch diameter open-graded or washed angular aggregate.
- The construction access road must extend at least 50 feet from the edge of the roadway.
- The minimum width of an access road is 12 feet.

Common Mistakes

- Failing to make sure all vehicles use the construction access road.
- Forgetting the geotextile fabric barrier.

Inspection and Maintenance

- Have the proper equipment onsite to remove the sediment from the road surface.
- Check the roads surrounding the construction site for sediment; if present, schedule sweeping or other means of removal.
- The construction access road must not contain ruts or sediment.
- Dust control may be required during dry conditions.
- The geotextile fabric must not be ripped, shifted, or subsiding.
- Install additional clean aggregate as needed.
- Install traffic barriers if vehicles are entering and leaving the site at unauthorized locations.

Tips

- ❑ Keep the construction access road in good working condition.
- ❑ Flare the entrance to the adjacent road to provide a turning radius.



This photo depicts problems that can arise even when a construction access road is properly installed. If it is not maintained properly, ruts can develop and sediment builds up. The access road needs to be regraded and new, clean aggregate must be added.

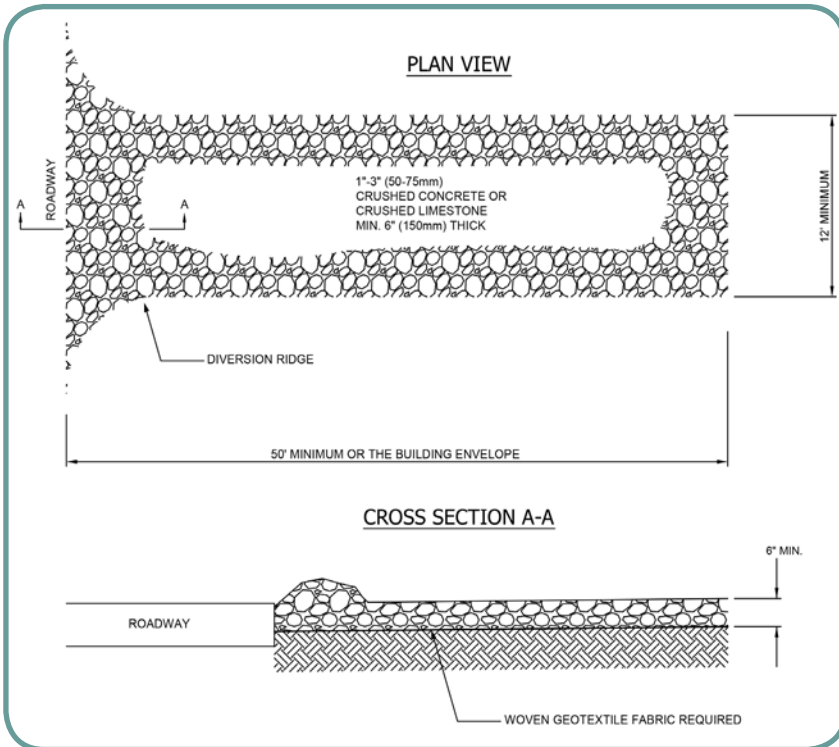

Figure 1-3 Temporary Construction Access Road



Chapter 2 Exposed Soil and Slopes

Surface Roughening.....	10
Seeding.....	11
Mulching.....	13
Silt Fences.....	15
Wattles	21
Erosion Control Blankets	22
Turf Reinforcement Mats.....	25
Polyacrylamides.....	27



Silt fencing is commonly used to pond, settle, and filter sediment from sheet runoff. Install at proper spacing on slopes; set back from slope toe to allow for maintenance. Make sure fencing is trenched in properly and stakes are on the downhill side. Inspect frequently to detect and address bypasses, undercutting, and overtopping.

EXPOSED SOIL AND SLOPES

Seeding or covering bare soil with mulch, blankets, mats, or other products as soon as possible is the most cost effective way to prevent erosion. Grass seeding alone can reduce erosion by more than 90%. Sod, mulch, blankets, and other products can further increase protection.

Surface Roughening

Surface roughening is an easy and economical method that simply creates an uneven or bumpy condition on the soil surface. It is used as a temporary practice to reduce the speed of runoff, increase infiltration, reduce erosion, trap sediment, and to prepare the soil for seeding and planting by capturing moisture for the seed.

General Installation

- Roughen the soil by **furrowing, scarifying, ripping,** or **disking** the soil.
- Create 2- to 4-inch variations in the soil depth.
- The grooves that are created by the surface roughening should be perpendicular to the direction of flow.

Common Mistakes

- The entire surface of the slope is not roughened.
- The grooves created are parallel to the flow. This creates



The photo shows a good example of surface roughening. The dozer is tracking up and down the slope creating grooves in the soil perpendicular to the direction of flow down the slope.



This photo illustrates improper surface roughening. The grooves are parallel to the direction of flow. Notice the sediment fines being deposited at the base of the slope due to erosion.

channels for the water to flow down the slope which increases the potential for erosion.

Inspection and Maintenance

- ❑ Ensure that the grooves created by the roughening are perpendicular to the direction of flow.
- ❑ Ensure that the entire surface of the slope has been treated.
- ❑ Ensure **rills** or **gullies** have not formed along the roughened surface.

Tips

- ❑ Drive the tracked vehicle up and down the slope to create grooves perpendicular to the direction of flow.
- ❑ If a roughened surface is the final **grade**, seed and mulch or other non-erodible surfaces should be installed within 5 days.

Seeding

Seeding, and the resulting vegetation, is an inexpensive but effective erosion control method. Vegetation controls erosion by physically protecting bare soil from **rain splash**, flowing water, and wind. The roots of the plants hold the soil in place. The vegetated areas reduce the velocity of the runoff and allow the water to infiltrate into the ground. Vegetation also reduces dust from the construction areas.

The seasonal window for successful seeding will vary from year to year based on moisture and temperature conditions. A successful seeding is more likely to result by planting in the middle of the suggested spring and fall seeding dates (refer to Table 2-1).

Table 2-1 Preferred Seeding Dates

Species	Spring	Fall
Permanent Grasses and Legumes	April 1 to May 20	August 10 to October 1
Native Grasses	Thaw to June 30	November 1 to Freeze/Snow

General Installation

- Grade the site to a workable slope.
- Where **compacted** soil is present, prepare the bare soil for planting by disking, scarifying, or tilling the bare area.
- Conduct soil tests to determine the need for fertilizer containing phosphorus. Provide and place the fertilizer as indicated by the soil tests.
- Place 3 to 4 inches of topsoil, free of large clods and debris.
- A **seedbed** must be dry with loose soil to a depth of 3 to 6 inches.
- Apply seed by hand, seeder, drill, or hydroseeder.
- Mulch slopes after seeding.
- Cover seed with erosion control blankets or turf reinforcement mats if slopes are 2H:1V or greater.
- Water as required.

Special Considerations

- Seed the area during the season specified by the supplier and within the preferred seeding dates (Table 2-1).
- Avoid seeding during drought conditions.

Common Mistakes

- Applying **fertilizer** without first testing the soil.
- Seeding outside of the preferred dates.
- Failing to install mulch or erosion control blankets to protect the seed.
- Seeding on frozen or snow covered ground

Inspection and Maintenance

- Ensure that the seeded areas are germinating.
- Ensure that the mulch or erosion control blankets are providing adequate cover and are properly anchored to protect the soil and seed.
- Look for damage to the vegetation from erosion or sediment deposition, vehicles, foot traffic, or animals.

- ❑ Maintain the seedbed, repairing and reseeding damaged areas. Look for patchy growth and reseed where needed.
- ❑ Look for areas where the mulch has been washed or blown away and re-mulch where needed.

Tips

- ❑ Obtain a seed mix containing minimal weed seeds.
- ❑ Check seed bag tags to make sure that the correct seed is used.
- ❑ Mix the seed thoroughly prior to loading the seeders.
- ❑ If seeding cannot be accomplished due to the season, use a temporary erosion control until the appropriate season.
- ❑ The grasses should emerge within 4 to 28 days and legumes 5 to 28 days after seeding.
- ❑ Do not seed until the spring thaw and never in the heat of the summer.

Mulching

Mulching is an erosion control practice that uses straw or **erosion control blankets** for the **temporary stabilization** of slopes and exposed areas. It can be used on newly seeded areas or when seeding cannot occur due to seasonal constraints.

Mulch should be anchored when there is a potential for it to move by wind or water. There are a variety of ways that mulch may be anchored. Hydraulic fiber mulches or tackifying agents are used effectively to bind the straw together. Mulch can also be covered by biodegradable netting, or it may be secured by disking or punching into the soil. However, netting should be used with caution because it can trap wildlife.

General Installation

- ❑ Mulch must be applied immediately after seeding.
- ❑ Mulch must cover the entire site; there should be no bare areas.
- ❑ Mulch may be installed by hand, with a mulch blower, or with a hydroseeder.
- ❑ Clean dry straw mulch is applied at a rate of 2 tons per acre, or approximately 1- to 2-inches thick.

- ❑ Anchor mulch on slopes greater than 2.5H:1V, or where the mulch is susceptible to movement by wind or water.
- ❑ Mulch may be anchored using netting, a **mulch anchoring disk**, or a **tackifier**.

Special Considerations

- ❑ Mulch tackifier shall be applied within 4 hours of mulch applications.
- ❑ Mulch tackifiers are water-soluble and must be reapplied 6 to 12 months after the initial application if plants have not germinated and the soil is not stabilized.
- ❑ On steep slopes or in areas of concentrated flow, erosion control blankets or turf reinforcement mats may be required.

Common Mistakes

- ❑ Insufficient mulch application to properly cover the area.
- ❑ Failing to anchor the mulch properly.
- ❑ Improper installation of anchor netting.

Inspection and Maintenance

- ❑ Inspect the mulched area weekly, after high winds, and after significant rain events.
- ❑ Look for bare areas and loose anchoring systems.
- ❑ Repair or replace any bare areas and damaged anchoring systems promptly.

Tips

- ❑ Mulch shall not be applied when windy conditions are present.
- ❑ Do not apply mulch during precipitation events or over snow.



The slope on the right is protected with properly installed mulch blanket. The slope shown on the left is unprotected. Rills and gullies have formed on the slope. The silt fence is not placed parallel to the contour or the slope.

Silt Fences

Silt fence is intended to remove sediment from runoff by slowing down the flow. This causes the sediment to drop out of suspension. The silt fence also acts as a filter, catching sediment as the water passes through. Silt fence should only be used to filter **sheet flow**, never for concentrated or channelized flow.

In areas that are generally flat or have gentler slopes, a silt fence with wooden stakes may be used (see Figure 2-1).

Slopes: Silt fences used in areas where there are steep slopes may need to be reinforced. Silt fences should be reinforced with woven wire and metal fence posts. Install wire fencing between the posts and the silt fence fabric, so that the pressure on the fabric from uphill flows is distributed across the wire fencing, then to the posts (see Figure 2-2). Multiple runs of silt fence may be required. See Table 2-2 for the recommended spacing of silt fences on slopes.

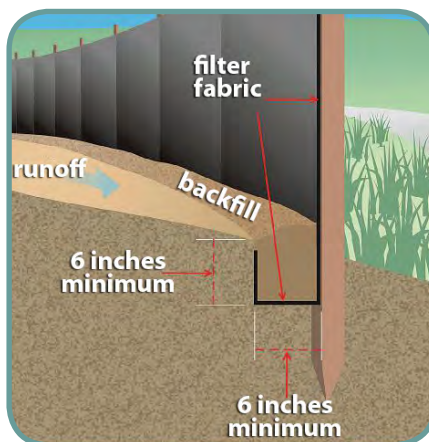

Remember: stakes go on the downhill side. Dig trench first, install fence in downhill side of trench, tuck fabric into trench, then backfill on the uphill side (the side toward the bare soil area).

Table 2-2 Silt Fence Spacing on Sloping Sites

Slope Angle	Soil Type		
	Silty	Clays	Sandy
Very Steep (1H:1V)	50 feet	75 feet	100 feet
Steep (2H:1V)	75 feet	100 feet	125 feet
Moderate (4H:1V)	100 feet	125 feet	150 feet
Slight (10H:1V)	125 feet	150 feet	200 feet

In some instances, where there is a lot of soil movement, **J-hooks** may be required. J-hooks are curved sections of silt fence that will prevent the soil from bypassing the silt fence and create an area for sediment to pond. J-hooks should be placed every 40 to 80 feet. (See illustration).

Winter Construction: Frozen ground can pose challenges for silt fence installation. Every attempt should be made to install silt fences before the ground freezes. If the ground is not frozen, standard installation guidelines apply. If the silt fence cannot be properly trenched in because of frozen ground, it should be installed with a 6-inch layer of peastone placed on top of the filter fabric. Refer to Figure 2-3.

General Installation

- ❑ Hardwood or metal stakes are installed with a maximum spacing of 6 feet and embedded in the ground at least 1 foot.
- ❑ Silt fence is fastened to the uphill side of the stakes facing the earth disruption and trenched into the ground a minimum of 6 inches. **Backfill** over the trenched-in fabric is compacted in place.
- ❑ The filter fabric is spliced together only at a fence post and securely sealed.
- ❑ The silt fences are installed along **contours** to avoid concentrated flows.
- ❑ Silt fences are installed approximately 5 feet away from the toe of the fill areas to allow an area for runoff to pond and sediment to settle.
- ❑ The drainage area tributary to the silt fence should not exceed 1/4 acre per 100 feet of silt fence.



Use J-hooks to trap and pond muddy runoff flowing along the uphill side of the silt fence. Turn ends of the silt fence toward the uphill side to prevent bypassing.

- ❑ On slopes, the silt fence is spaced according to Table 2-1 and is properly reinforced with wire support fence.

Special Considerations

- ❑ When installed on frozen ground, the toe of the fabric is placed on the ground instead of being trenched in. A minimum of 6 inches of peastone is provided on top of the fabric toe to hold it in place.
- ❑ Ensure that the silt fences adjacent to sensitive areas have not been breached and that the buffer is still intact.

Common Mistakes

- ❑ Placing silt fences perpendicular to contour (up and down hills).
- ❑ Placing silt fences above (uphill from) areas of bare soil.
- ❑ Placing silt fences in areas of **concentrated flow** such as ditches, **channels**, or streams.
- ❑ Placing stakes on the uphill side of the fence.

Inspection and Maintenance

- ❑ Replace torn fabric and damaged stakes.
- ❑ Silt fences must be taut; replace if sagging.
- ❑ Remove all sediment from behind the silt fences when it reaches approximately 1/3 of the fence's height.
- ❑ Make sure that ends of fences are wrapped.
- ❑ Silt fences must be removed after serving their useful purpose.
- ❑ Upon silt fence removal, rake, apply topsoil, and stabilize the area.

Tips

- ❑ Silt fences must be installed prior to any site grading.
- ❑ Silt fences must remain in place and must be maintained until the **disturbed area** is stabilized.
- ❑ Seed and mulch the **upland** areas as soon as possible.
- ❑ Leave room for sediment removal and/or maintenance.
- ❑ Do not use silt fences for delineation of no-work zones.
- ❑ Once the site has been permanently stabilized, remove the silt fences then rake, seed, and mulch the area where the fences were removed.

This photo illustrates good perimeter control. The work area is well defined and the receiving stream is well protected with a properly installed reinforced silt fence. The silt fence is well maintained with no torn or sagging fabric and no damaged stakes.



This is an example of a poorly placed silt fence. Silt fences should not be placed across ditches, swales or any other areas of concentrated flow. This silt fence is not installed parallel to the contours.



Silt fences should not be allowed to sag. Sediment should be removed from behind the silt fence when it accumulates to 1/3 the exposed filter fabric height. Sufficient space should be left behind the silt fence to allow for maintenance and the removal of sediment.



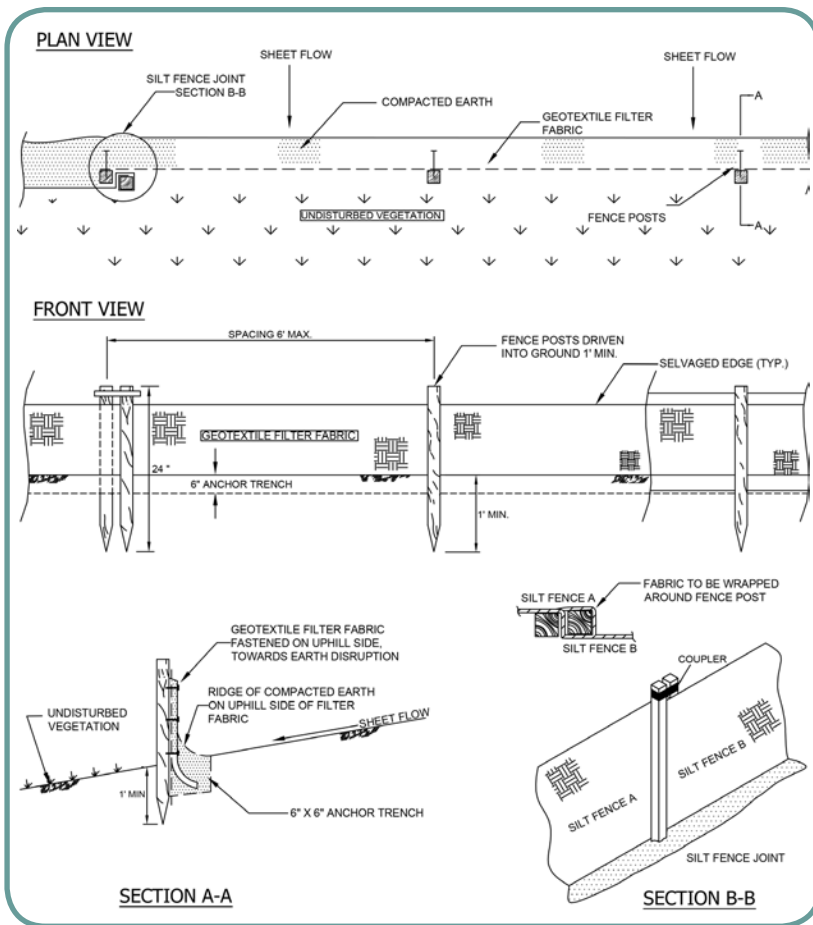

Figure 2-1 Silt Fence

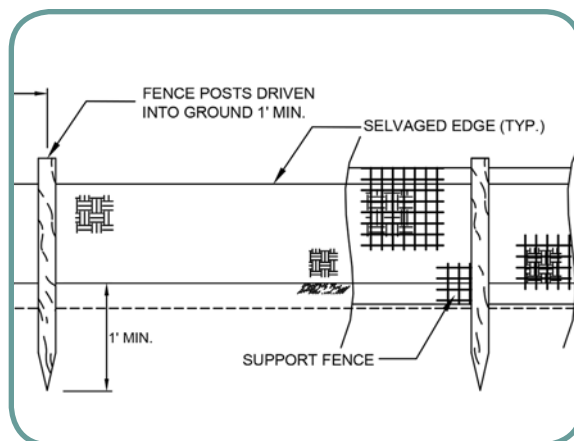

Figure 2-2 Support Fence Attached to Silt Fence

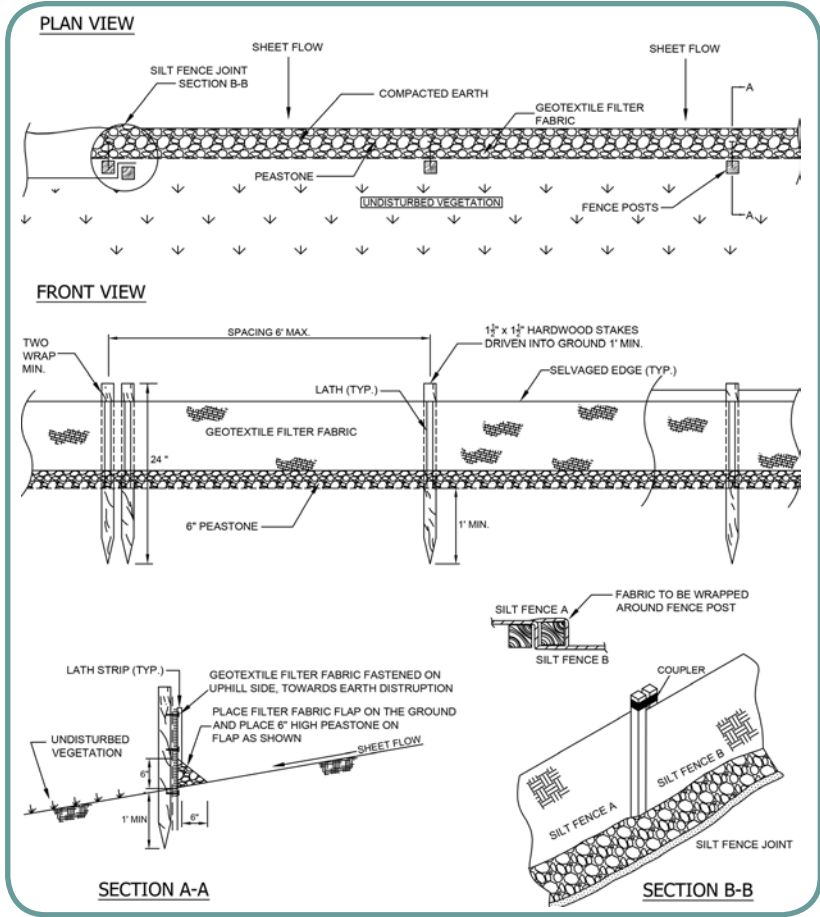

Figure 2-3 Silt Fence Installed on Frozen Ground

Wattles

Wattles are fiber rolls that are made with coconut fiber, plastic, wood shavings, straw, or other materials. They are placed and staked along the contours and disrupt sheet flow runoff. The advantages of wattles are that they can blend in with the surrounding landscape and are less obtrusive than a silt fence. Installation is quick and simple, and they can be left in place after vegetation is established if they are made from a biodegradable material.

General Installation

- Ensure that the wattle used is appropriate for the application and the anticipated runoff flows.
- Excavate a 2- to 4-inch trench for the wattle to sit in.
- Press rolls firmly into the trench.
- Stake the wattle in place with 2-foot-long hardwood stakes that are spaced no greater than 4 feet apart.
- Turn the ends of the wattle uphill slightly to minimize the opportunity for runoff to flow around the ends.

Special Considerations

- Wattles are produced by a number of manufacturers and are available in a wide variety of sizes and materials for different applications.
- Installation and maintenance of manufactured devices may differ. The manufacturer's installation and maintenance procedures should be followed.

Common Mistakes

- Failing to excavate a shallow trench for the wattle.
- Improperly anchoring the wattle.

Inspection and Maintenance

- Inspect and repair any gaps that appear at the upturned edge of the wattle. Fill any gaps with an erosion control blanket.
- Add additional stakes to the wattle if there is evidence that the roll is folding in on itself.

Tips

- ❑ Seat the wattle with tamped backfill on the upstream side so that water flowing down the slope will not run under it.
- ❑ Place stakes upslope of the wattle to help hold it in place during larger rain events.

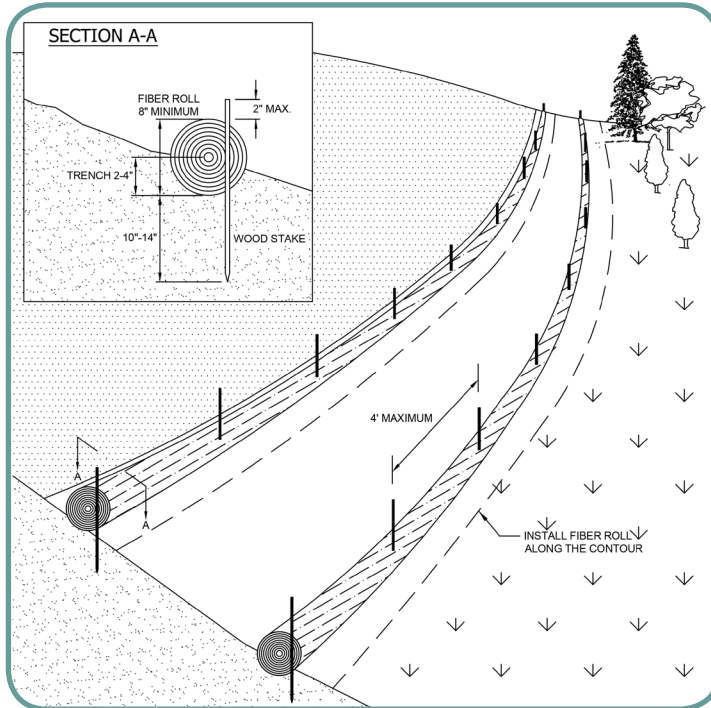

Figure 2-4 Wattle Installation

Erosion Control Blankets

Erosion control blankets are used to protect steep slopes and other areas where the potential for erosion is high. Most are designed to provide temporary stabilization until the vegetation is established. Erosion control blankets may degrade within 6 to 24 months, depending on their composition. They usually consist of a layer of straw, coconut fiber, wood fiber, or jute sandwiched between layers of plastic or fiber mesh. Low velocity erosion control blankets have netting on one side, and the high velocity blankets have netting on both sides.

General Installation

- ❑ The disturbed area must be uniform, with no large rocks, vegetation or rilling on the surface, before placing the erosion control blankets.
- ❑ Ensure that the erosion control blanket used is appropriate for the angle of the slope and the anticipated flows.
- ❑ Areas where the erosion control blankets are to be used must be properly prepared with topsoil, fertilized if required, and seeded before the blankets are placed.
- ❑ The erosion control blankets must be placed smoothly but loosely on the soil surface without stretching.
- ❑ The erosion control blankets at the top and bottom of the slope must be trenched in 6 inches wide by 6 inches deep.
- ❑ Trenching at the top of the slope must be beyond the crest of the slope to avoid undercutting.
- ❑ The erosion control blankets must be anchored in accordance with the manufacturer's installation guidelines.
- ❑ The uphill layers of the erosion control blanket should overlap the downhill layers.
- ❑ Overlap the adjacent erosion control blankets by 6 to 8 inches.
- ❑ Staple through both blankets at the overlaps.

Special Considerations

- ❑ For short slopes (8 feet or less) above channels, install blankets across the slope (horizontal).
- ❑ Install perpendicular to the hill (vertically) for long slopes.

Common Mistakes

- ❑ Selecting an incorrect erosion control blanket for site conditions.
- ❑ Improperly anchoring the erosion control blankets.
- ❑ Using incorrect materials to anchor the erosion control blanket.
- ❑ Installing erosion control blankets on an ungraded surface.

Inspection and Maintenance

- ❑ Look for channels forming under the blanket.

- Re-anchor loose matting.
- Replace missing matting and staples as required.

Tips

- Do not use on already vegetated slopes or ditches.
- Do not stretch the blankets during installation.
- Do not use steel pins or staples in areas to be mowed.
- Use plenty of staples to keep the erosion control blankets flat.
- Do not exceed the manufacturer's recommendation for the maximum slope angle for the product.
- Do not exceed the manufacturer's recommendations for the anticipated flow velocities.

Install blankets vertically on long slopes. Unroll the erosion control blanket from the top of the hill. Staple the blanket as it is unrolled. Do not stretch blankets. Make sure to overlap the adjacent layers.

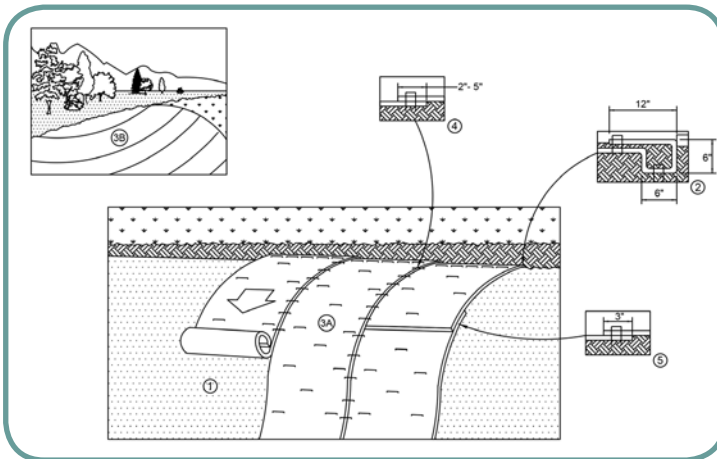
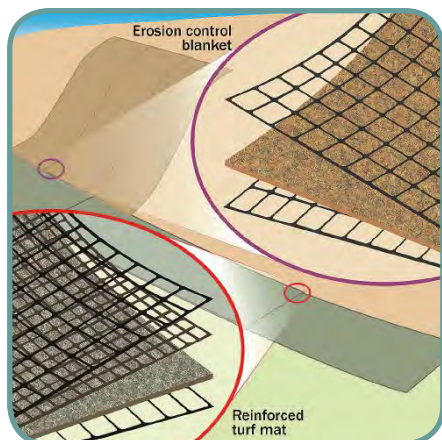

Figure 2-5 Installation of Erosion Control Blanket on Slope



Turf reinforcement mats can be temporary or permanent. They are thicker and degrade slower than erosion control blankets.

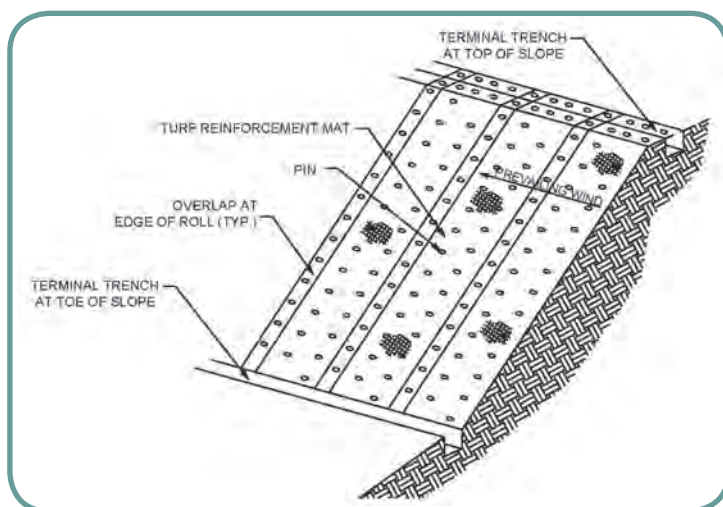

Figure 2-6 Turf Reinforcement Mat Installation on a Slope

Turf Reinforcement Mats

Turf reinforcement mats (TRMs) are similar to erosion control blankets, but they are thicker and sturdier because they have more layers and sturdier fill material. TRMs provide greater protection than erosion control blankets. TRMs last longer in the field than traditional erosion control blankets because of their heavier construction. TRMs can be temporary or permanent.

TRMs are used for steep slopes (3H:1V or steeper) and ditches or channels with 15H:1V to 10H:1V slopes. In general, TRMs are installed the same as erosion control blankets. There are some exceptions; in some instances you place soil, seed, and mulch over the TRM to reinforce the roots of the vegetation. Additional staking or stapling is needed for applications in channels that carry flowing water, and on steep slopes.

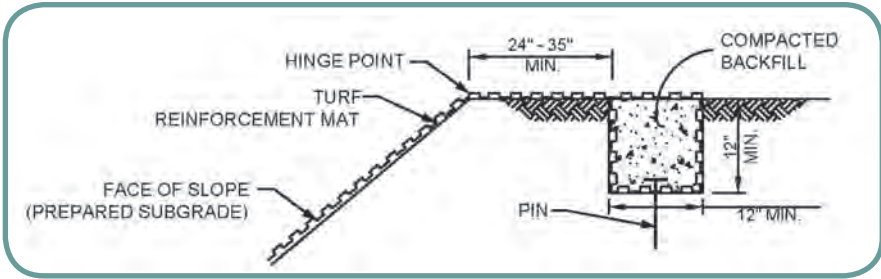

Figure 2-7 Turf Reinforcement Mat Initial Trench at Top of Slope

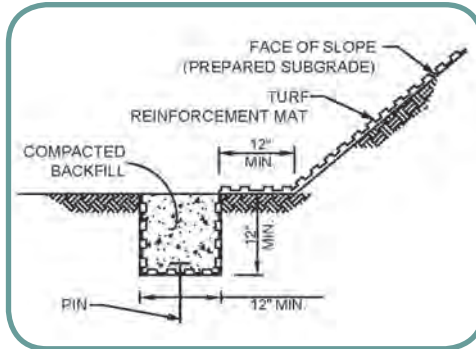

Figure 2-8 Turf Reinforcement Mat Terminal Trench at Toe of Slope and Longitudinal Edge Terminations

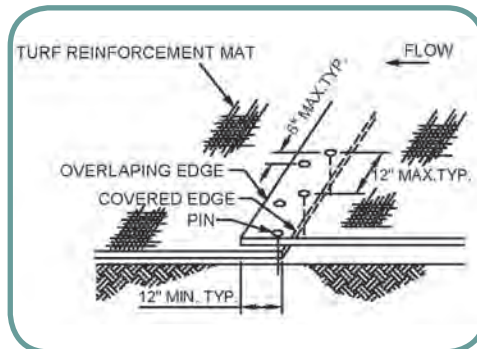

Figure 2-9 Turf Reinforcement Mat Joint Detail

Polyacrylamide

Anionic **polyacrylamide** (PAM) and other chemical soil binders and stabilizers have been proven to be effective in controlling erosion on bare soils and may be used as a water treatment additive to remove sediment from runoff. PAMs are polymer-based materials used to facilitate erosion control by binding soil particles, especially clays. PAMs increase the soil's available pore volume, thus increasing infiltration and reducing the quantity of **stormwater** runoff that can cause erosion.

PAMs may be used on their own or with seed, mulch, erosion control blankets, turf reinforcement mats, and sediment basins.

General Installation

- Only anionic PAMs are approved for use in the State of Michigan for erosion and sediment control.
- Use PAMs according to the approved soil erosion plan for the site.
- PAM application rates are site specific and soil testing is required. Determine the correct form of PAMs to be used and the appropriate application rate based on site soil tests.
- Obtain and follow all Material Safety Data Sheet (MSDS) requirements and manufacturer's recommendations.
- Apply and store the PAMs according to the manufacturer recommendations.
- Use 25 foot minimum setbacks when applying anionic PAM near natural water bodies.
- The use of PAMs in or near waterbodies must be approved by the Michigan Department of Environmental Quality (MDEQ).
- Mulch to protect the seed if it is applied with anionic PAM.

Special Considerations

- This type of protection is only temporary.
- Repeat applications, or seed and mulch, if other actions are still needed for permanent slope protection.
- Cationic PAMs are not approved for use for erosion and sediment control in the State of Michigan and should not be used.

Common Mistakes

- Running equipment on treated areas.
- Using an incorrect application rate for the soil type.
- Applying PAMs to pure sand and gravels. PAMs are not effective when applied to these materials.

Inspection and Maintenance

- Look for areas with signs of erosion.
- Rill erosion indicates poor product mixture and/or application.
- Reapply anionic PAM to disturbed areas as needed.

Tips

- Never add water to PAM; add PAM slowly to water. If water is added to PAM, clumping can form, which can clog dispensers.
- Consider that the performance of PAMs decreases with time and exposure to ultraviolet light.
- PAMs and other chemical binders are soil type-specific so a contractor cannot use leftover material at another site or bulk order for multiple sites.
- Overuse may clog soils, thereby decreasing infiltration.
- Use soil binders on stockpiles to reduce wind erosion.

Chapter 3 Ditches

Erosion Control Blankets and Turf Reinforcement Mats for Ditches	30
Check Dams	32
Riprap	34
Gabions	37



Wide and relatively flat ditches can be protected with seed and mulch. Steeper ditches (e.g., slopes of up to 10% and more in some cases) can also be seeded if turf reinforcement mats are used. Check dams can help to control downcutting in drainage ditches before grass is well established.

DITCHES

Man-made drainage ditches with gently sloping bottoms (less than 3%) can be stabilized with grass and erosion control blankets (see Chapter 2). Moderately sloping ditches (3% to 6% slopes) will likely require turf reinforcement mats (TRMs) and perhaps some **riprap** if the soils are silty. Ditches with steep slopes (greater than 10%) need **hard armoring** with, riprap, **gabion** baskets, geogrid, retaining walls, or other approved products. Drainage ditches often need **check dams** to reduce the speed of water and capture sediment.

Erosion Control Blankets and Turf Reinforcement Mats for Ditches

All ditches steeper than 10% require hard armoring (riprap, gabions, or equivalent hardened material) and/or **grade control structures**. Ditches of 10% or less can be stabilized with turf reinforcement mats or erosion control blankets if they are seeded quickly.

Erosion control blankets and TRMs for ditches are similar products to those discussed in Chapter 2 for exposed soil and slopes. Refer to the general installation, common mistakes, inspection and maintenance, and tips provided in Chapter 2.

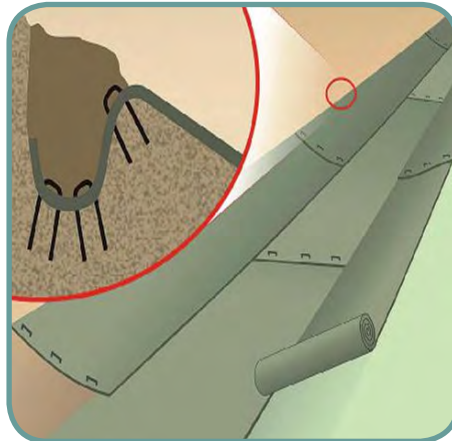

Start at the downstream portion of the ditch and work upstream. Ensure that the upstream edge of the blanket overlaps the down stream edge of the blanket. Staple through both layers at joints and around the edges. Trench, tuck, and tamp down ends at the top of the slope. Do not stretch blankets or mats.



Start at the downstream portion of the ditch and work upstream. Ensure that the upstream edge of the blanket overlaps the down stream edge of the blanket. Staple through both layers at joints and around the edges. Trench, tuck, and tamp down ends at the top of the slope. Do not stretch blankets or mats.

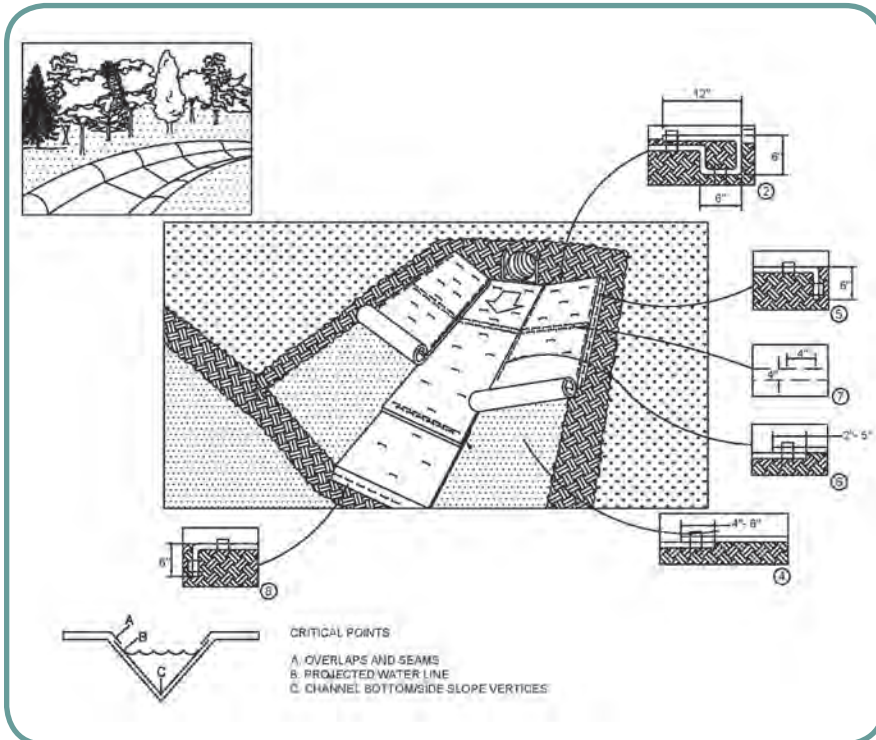

Figure 3-1 Erosion Control Blanket Ditch Installation

Check Dams

Check dams are relatively small structures that are constructed across ditches. The primary purpose of a check dam is to slow the water down to a non-erosive velocity. Check dams are commonly constructed of rock or wattles.

Check dams can also function as sediment controls if the runoff is slowed sufficiently to allow the larger sized particles to settle out of the water. The deposition of sediment can be increased by excavating sumps upstream of the check dam.

General Installation

- Seed the ditches and install the check dams before excavating, filling, or **grading** uphill areas.
- For rock check dams, excavate and set the rock 6 inches below the channel grade.
- Make sure that the rock used to construct the check dams are properly sized for the anticipated flows.
- The middle of the dam must be 9 inches lower than the outer edges and the edges should be tied into the slope. This allows water to flow over the depression in the center as opposed to around the sides where it could erode the banks. The middle of the dam should be roughly the width of the ditch at the bottom.
- Check dams must be spaced so that the toe of the upstream check dam is at the same elevation as the lowest point of the top of the downstream check dam.
- Construct a sediment trap upstream of the check dam to improve sediment capture.
- Place riprap downstream of check dams to help dissipate the energy of the water flowing over the dam.
- Check dams greater than two feet in depth may seriously impact the flow characteristics of the ditch.

Common Mistakes

- The top of the dam is set level or taller in the center than on the ends, forcing water around the sides of the check dam.
- The check dams are spaced too far apart.

- ❑ Temporary check dams are not removed after construction.
- ❑ The middle of the check dam is not the appropriate width for the ditch.

Inspection and Maintenance

- ❑ Inspect the check dam for signs of erosion and settlement. Repair immediately when necessary.
- ❑ Remove accumulated sediment from the upstream side of a check dam when the sediment has reached a height of approximately 1/2 the original height of the check dam.
- ❑ Remove temporary check dams when the channel is stabilized.

Tips

- ❑ Silt fence, hay, or straw bales cannot be used as check dams.
- ❑ Vegetate the drainage channel if possible.
- ❑ Placing filter fabric under the check dam during installation will make removal much easier.
- ❑ Make sure to remove the check dam once the ditch is stabilized.

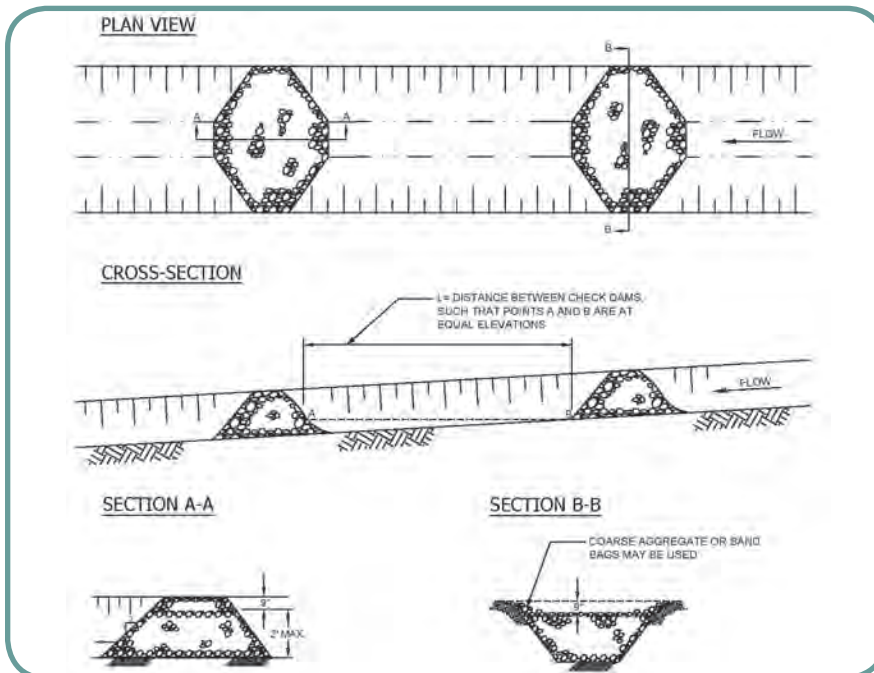

Figure 3-2 Rock Check Dam

This photo depicts the proper installation of a rock check dam. The middle of the dam is lower than the ends. A sediment trap is upstream of the check dam to increase sediment removal.



This photo illustrates the improper installation and maintenance of a rock check dam. The ends of the check dam are lower than the middle, allowing water to flow around it.



Riprap

Riprap provides an effective non-erodible cover for overexposed areas. It can protect areas from erosion caused by wind, rain, and snowmelt. Riprap installed at culvert outlets can protect the stream bed and channel from erosion. Sizing of the riprap is based on the shear force anticipated during high flow conditions.

General Installation

- Excavate so that the final grade of the riprap will be flush with the surrounding soil.
- Install a **geotextile** or aggregate filter layer under the riprap.

- ❑ Install the riprap according to the design, paying special attention to the upstream edge and the toe (the two most sensitive areas).
- ❑ The depth of riprap should be 1-1/2 times the maximum stone diameter or 12 inches (whichever is greater).
- ❑ Disturbed areas around the riprap should be stabilized with seed, mulch, vegetation or sod.

Common Mistakes

- ❑ Improperly installed riprap at the upstream edge and at the toe of the slope. These transition areas require extra riprap thickness.
- ❑ Exposed geotextiles allowing water to seep behind riprap. Geotextiles must be properly anchored before the riprap installation.
- ❑ Geotextile substitutions often lead to failure. The geotextiles are carefully selected to provide separation of the riprap with the native soil and to allow drainage of the slope.

Inspection and Maintenance

- ❑ Inspect the perimeter edge of the riprap. Look for signs of erosion, settling and exposed geotextile.
- ❑ If the bottom of the riprap is not accessible (covered by water), pay special attention to the top edge for signs that the riprap is sliding down the slope, a common sign of toe failure.
- ❑ Inspect the riprap for proper thickness and signs of failure.
- ❑ Immediately repair damaged areas.

Tips

- ❑ The riprap should be constructed of natural stone, solid precast concrete blocks, or sound pieces of broken concrete.
- ❑ Ensure that the riprap is appropriately sized for the slope and the anticipated flows.
- ❑ The riprap must be free of soil, visible rebar, and debris.

This is an example of an improper riprap installation. The toe of the riprap slope was not constructed properly, the geotextile was left exposed and not anchored, and the riprap surface was set above the surrounding ground surface.



This photo shows an example of properly installed riprap. It was installed as part of a bioengineered streambank. The system is stable and shows no sign of erosion.

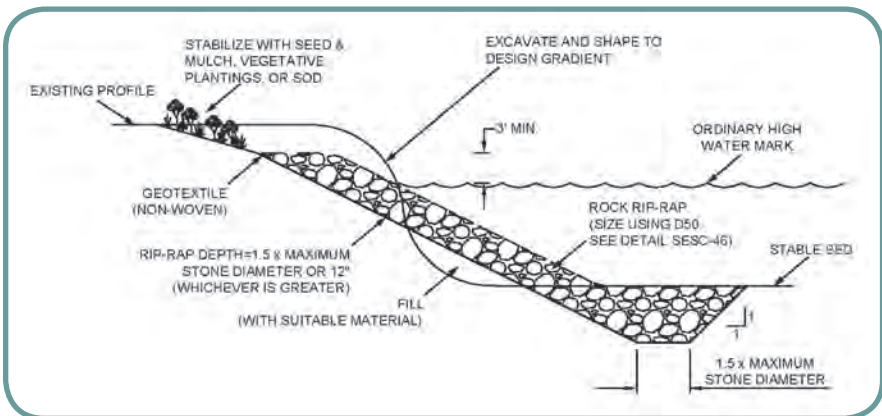

Figure 3-3 Riprap Installation, Steep Bank Application

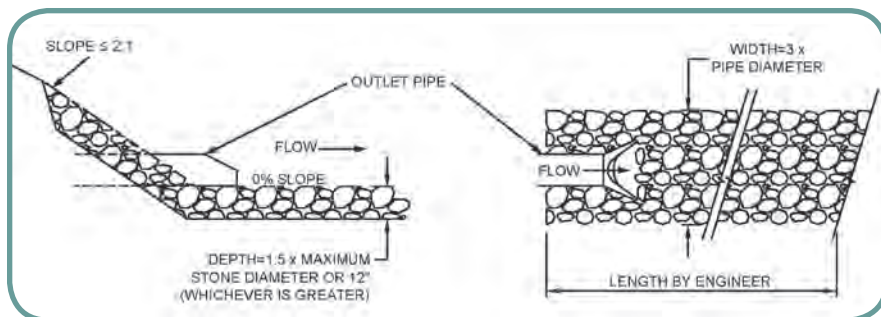

Figure 3-4 Riprap Installation, Pipe Outlet Application

Gabions

Gabions are constructed by filling large galvanized steel baskets with rock. A gabion wall is a retaining wall made of stacked gabion baskets tied together. Gabions are used to stabilize shorelines, streambanks, or slopes against erosion. Gabions may also be placed as a mattress which is relatively thin, but long and wide. Gabions conform to minimal shifts in the soil, and are adaptable to a wide variety of applications.

General Installation

- ❑ Remove the loose material to provide a firm foundation for the gabion basket.
- ❑ The wire mesh, which makes up the gabion basket, should be no smaller than 12 gauge. Mesh size will vary, depending on the rock size used to fill the basket. Nine-gauge wire should be used for all ties and lacing.
- ❑ Place non-woven geotextile fabric on the bank to prevent loss of fine grained soils into gabions. Secure ends at least every 8 inches along seams. A minimum of 2 ties should be made between gabions for every square foot of contact area.
- ❑ Fill voids between the **excavation** area or bank with gravel and cobble fill.
- ❑ Provide loose rock riprap transition zones if necessary.

Special Considerations

- ❑ The proper design and construction of a base for the gabion to sit on is important. Most gabion walls can be built without a concrete foundation.

- ❑ When constructing gabions on softer soils, both the depth of the toe and the size of the base need to be increased to spread the load over a wider area.

Common Mistakes

- ❑ Insufficient compaction of the base and the backfill material.
- ❑ Improperly tying the gabion baskets.

Inspection and Maintenance

- ❑ Inspect the gabion locations following spring or peak water flows and after severe weather events.
- ❑ Look for undercutting, streambank failure, or other signs of erosion.
- ❑ Check the condition of the wire mesh, ties, and lacing. The wires may be damaged from debris carried by floodwaters.
- ❑ Repair the gabions as needed.

Tips

- ❑ Inclined walls have improved stability.
- ❑ Problems with the wire baskets are easy to fix if caught early. Problems not corrected often lead to failures of the gabion baskets, resulting in more costly repairs.

This is a good example of gabion baskets that were installed to stabilize a channel and to prevent head cutting.



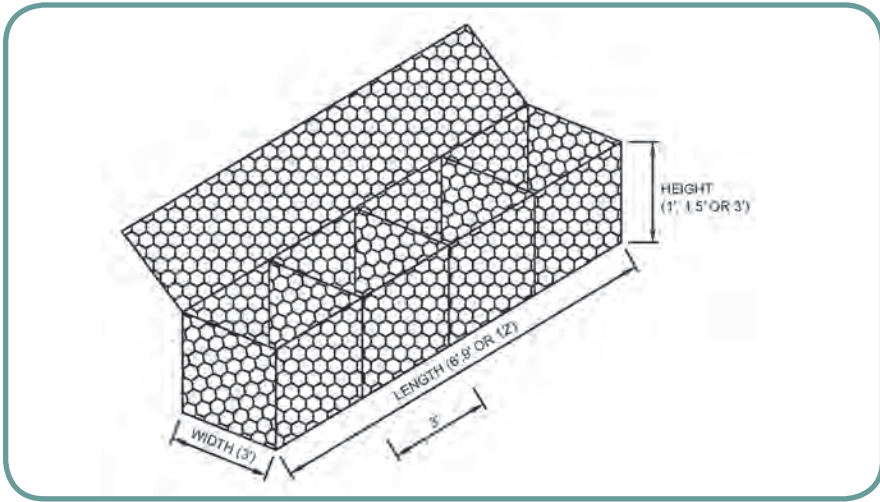

Figure 3-5 Gabion Basket

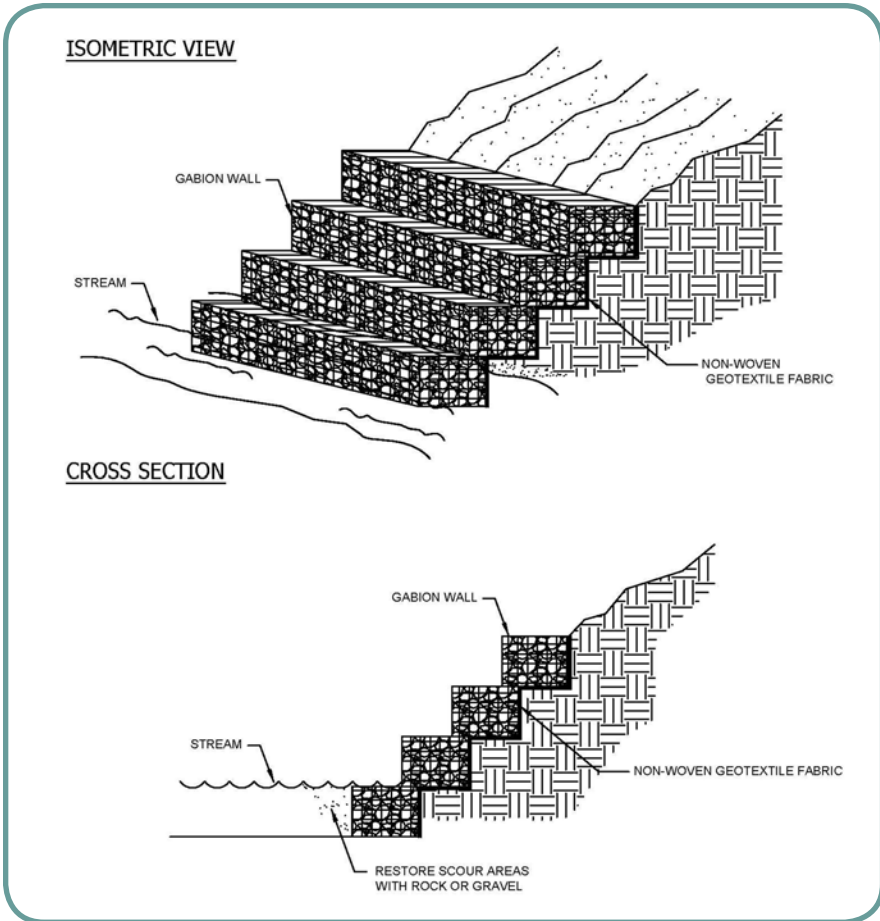

Figure 3-6 Gabion Wall



Chapter 4 Inlet and Outlet Protection

Inlet Filters.....	42
Outlet Pipe Riprap Protection.....	52
Detention Basin Outlet Filter.....	54



Protect stormwater inlets with commercial dike products or site-fabricated ponding berms made of rock, wire, or other material. If the inlet filter system is causing ponding in the roadway, an inlet filter bag or other low-profile product may be beneficial. For best results, sediment should be retained on the landscaped areas and not discharged into roadways or parking lots. This photo shows an example of commercially available inlet filter bags that are properly installed and effectively protecting two inlets.

INLET AND OUTLET PROTECTION

One of the most important protection measures on any given construction site is **storm drain inlet** protection. All of the inlets on the site must be protected using approved filters prior to beginning any construction activity. These filters must be maintained throughout the entire construction period and removed once the site has been stabilized.

Outlets from pipes and basins must also be protected; failure to do so may cause the soil supporting the structure to erode if high velocities are present.

Inlet Filters

An **inlet filter** is needed when muddy runoff flows toward a culvert, ditch, or storm drain inlet. The water must be filtered or slowed down and pooled to allow the sediment to settle out. Only after the sediment is removed should the water be allowed to enter the inlet.

This section describes several inlet filter strategies. If the drainage area above the inlet is greater than 3 acres, a sediment trap or basin (see Chapter 5) is needed. For all inlet filter approaches, seeding and mulching upland areas promptly will greatly reduce the incoming runoff volumes and sediment loads.

There are three basic types of inlets: area drains, curb and gutter inlets, and culvert inlets.

- **Area Drains.** These inlets have either a flat or beehive grate and are located at the low points of the site. They are present in both paved and greenbelt areas.
- **Curb and Gutter Inlets.** These inlets are located in roads and parking lots and typically have a flat grate in the gutter pan and may also have an open vertical face along the curb.
- **Culvert Inlets.** Culvert inlets are located in ditches and transition the flow from an open channel to piped flow. Most culverts are relatively short, passing under a driveway or roadway. The best method of preventing suspended sediment from entering a culvert is to stabilize the ditch (refer to Chapter 3).

There are also three basic locations to filter the muddy runoff: upstream of the inlet, at the face of the inlet, or inside the inlet.

- Upstream of the Inlet. Upstream strategies include practices such as silt fence, erosion logs, rock, and vegetated filters.
- Inlet Face. The only practice available at the face of the inlet is a geotextile filter fabric, sometimes with a rock layer over the fabric.
- Inside the Inlet. Various products are available to install inside the inlet. These products include a basket or bag to catch the sediment and an overflow for high flow conditions.

There many different combinations of filtering strategies and locations where the filters are employed. Figures 4-1 through 4-9 illustrate many of these approaches. The fundamental installation, special considerations, and inspection and maintenance of the filtering strategies are similar.

General Installation

Inlet Face

- Wrap grate with geotextile filter fabric, covering the top surface.
- The geotextile must be anchored in place with the grate.
- Peastone may be used over top of the geotextile fabric to provide additional protection.

Sod Around the Inlet

- Stagger the sod in adjacent rows and butt joints tightly. Do not overlap joints or stretch sod.
- Anchor the sod with pins or stakes if placed on slopes greater than 3H:1V.
- Roll or tamp sod after installation and water immediately.

Silt Fence Upstream of Inlet

- Silt fence must be trenched in, held taut, and supported by stakes. It may require additional support with wire fencing.
- When the ground is frozen, the toe of the silt fence may be held down by peastone.

Erosion Logs and Wattles Upstream of the Inlet

- Relatively light weight erosion logs and wattles must be trenched and anchored in place.

Block and Gravel Upstream of the Inlet

- Use concrete blocks (or the equivalent) to create a temporary wall for the gravel to rest against. Concrete blocks are laid such that water can pass through and to prevent movement.
- Place a wire mesh over the outside vertical face of the concrete blocks to prevent the gravel from being washed through the holes in the blocks.

Inlet Filter Basket or Bag

- Purchase and install devices that are correctly sized for the inlet structure.
- Frames or filters should fit tightly around inlets and eliminate bypass opportunities.
- Have extra devices available.

Special Considerations

- Filter types that directly cover the face of an inlet have the highest risk of flooding since there is no overflow pathway in the event the filter clogs.
- Minimize flooding potential by ensuring that the top elevation of the inlet filter is at least 6 inches lower than the ground elevation of nearby structures.
- Inlet filter bags are very heavy when full and may need to be removed with heavy equipment.

Common Mistakes

- Punching holes in geotextiles to promote drainage.
- Using silt fence to wrap inlet grates or as a backing for gravel.
- Using straw or hay bales as an inlet filter.
- Having a filter that is not held tightly to the ground surface, allowing water to pass underneath.

Inspection and Maintenance

- ❑ Remove and dispose of sediment as necessary. Never wash sediment or other materials down inlets.
- ❑ Vegetated areas should be inspected for signs of erosion. Sod should be inspected for gaps in the joints and signs of water getting underneath the sod. Repair problem areas immediately. Water vegetated areas as needed.
- ❑ Silt fence (refer to Chapter 2) should be inspected for torn or sagging fabric, damaged stakes, and bulging from sediment buildup. Remove all sediment from behind the silt fence when it reaches approximately 1/3 of the fence height.
- ❑ Use a gravel barrier around the perimeter of inlets when stormwater enters the inlet at a high speed or is carrying a significant amount of sediment.

Tips

- ❑ Upland area should be seeded and mulched as soon as possible to minimize sources of sediment approaching inlets.
- ❑ Use a gravel or silt fence barrier around the perimeter of inlets when stormwater enters the inlet at a high speed or is carrying a significant amount of sediment.
- ❑ Make sure to remove the inlet protection when construction activities are complete, unless it is a permanent practice.
- ❑ Inlet filter bags can be reused if they are not damaged and have been washed out after prior use.

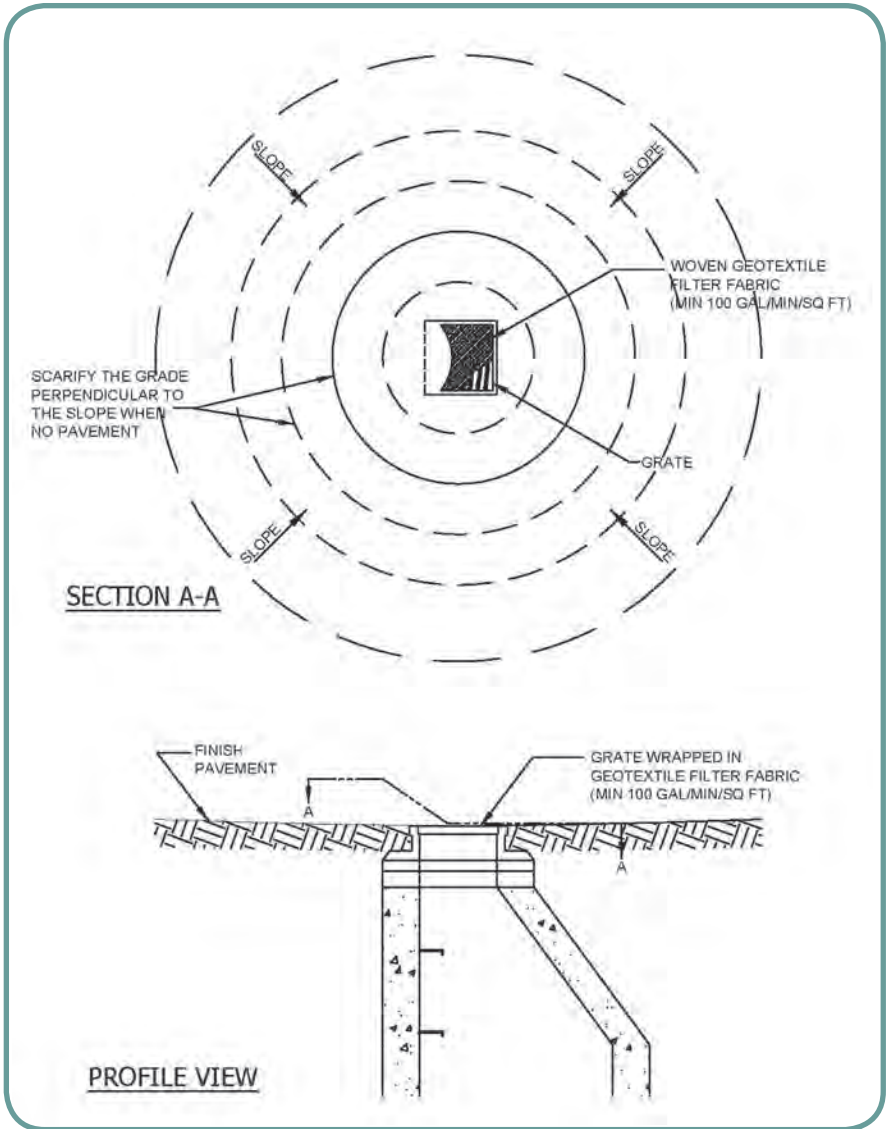

Figure 4-1 Low Point Inlet Filter

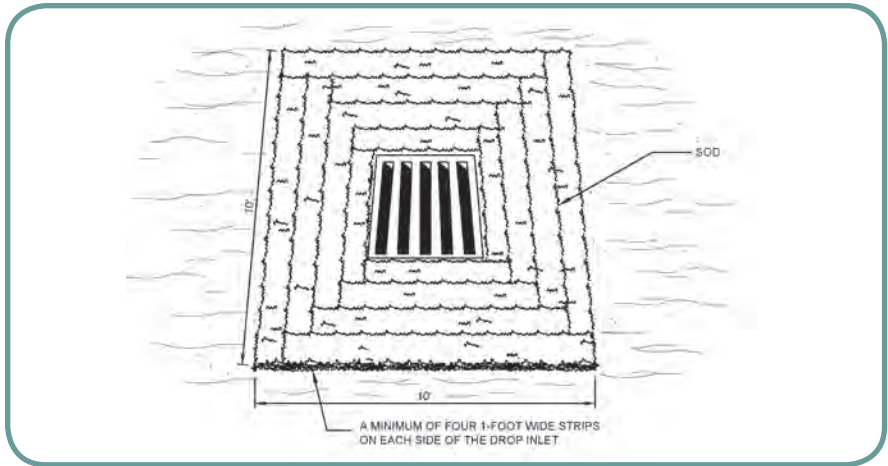

Figure 4-2 Sod Inlet Filter

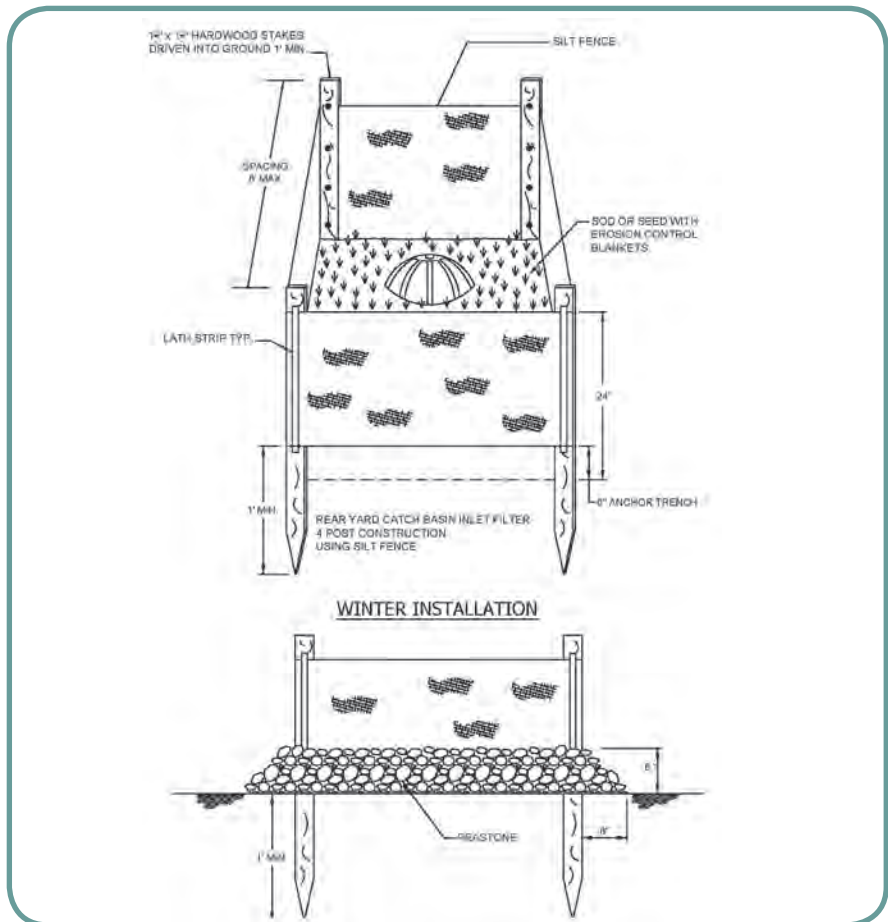

Figure 4-3 Rear Yard Catch Basin (RYCB) Inlet Filter

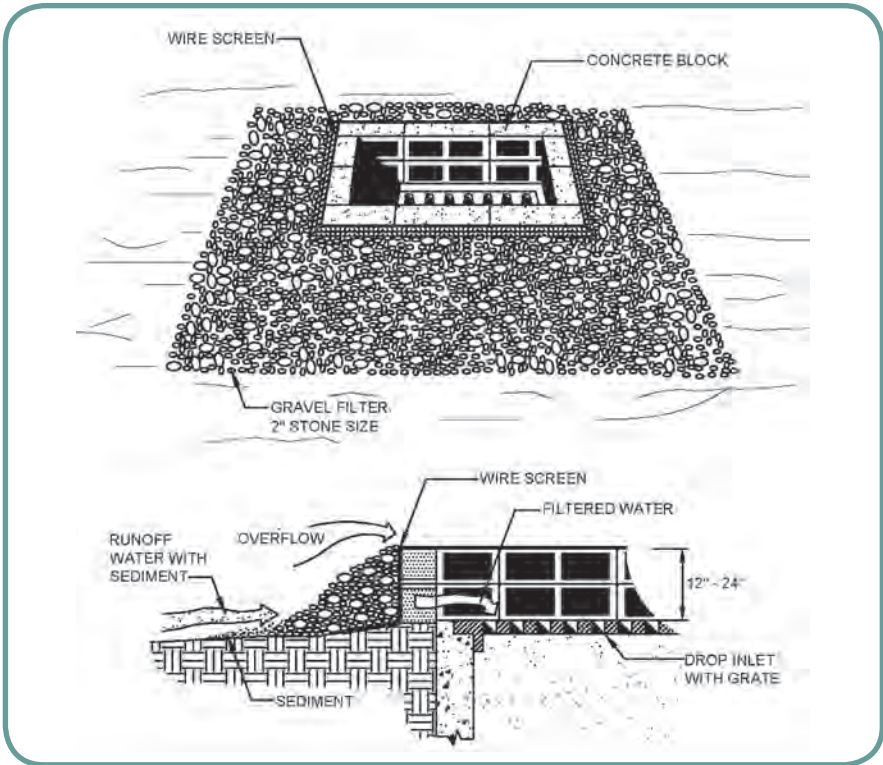

Figure 4-4 Block and Gravel Inlet Filter for Area Drain

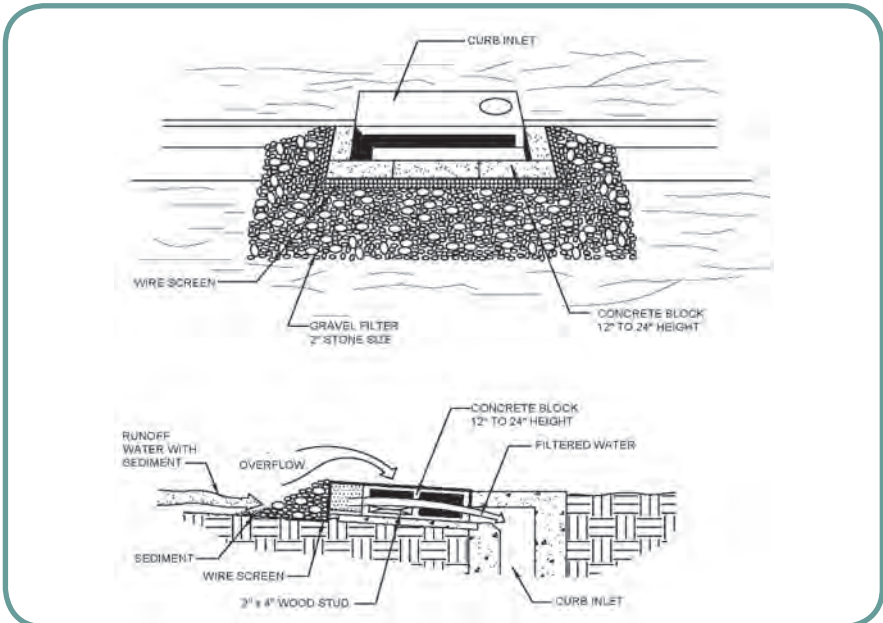

Figure 4-5 Block and Gravel Inlet Filter for Curb and Gutter Inlet

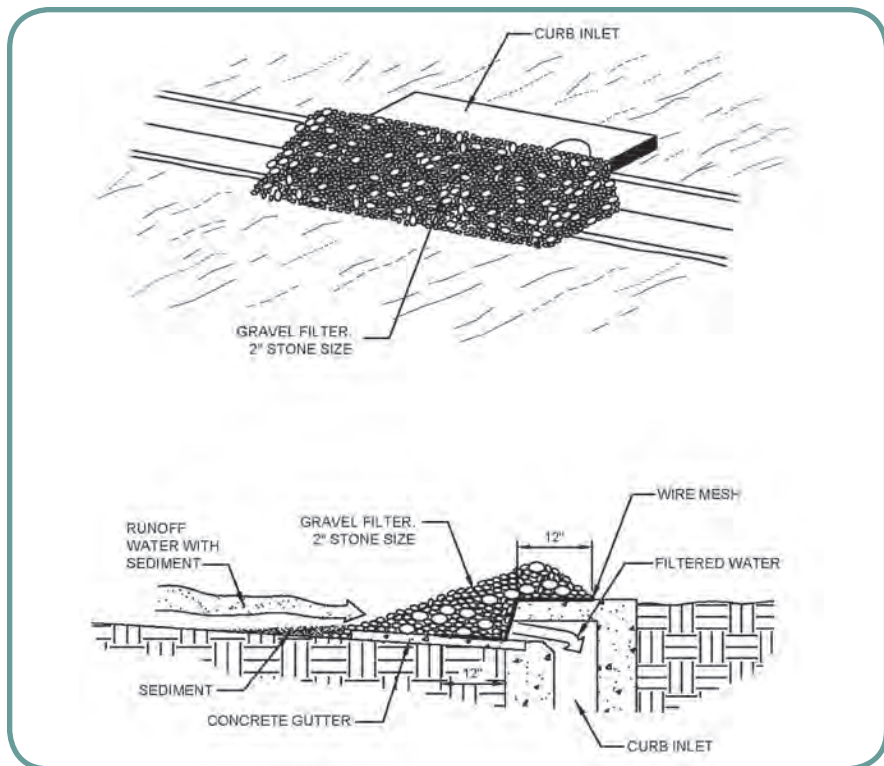

Figure 4-6 Curb Inlet Filter

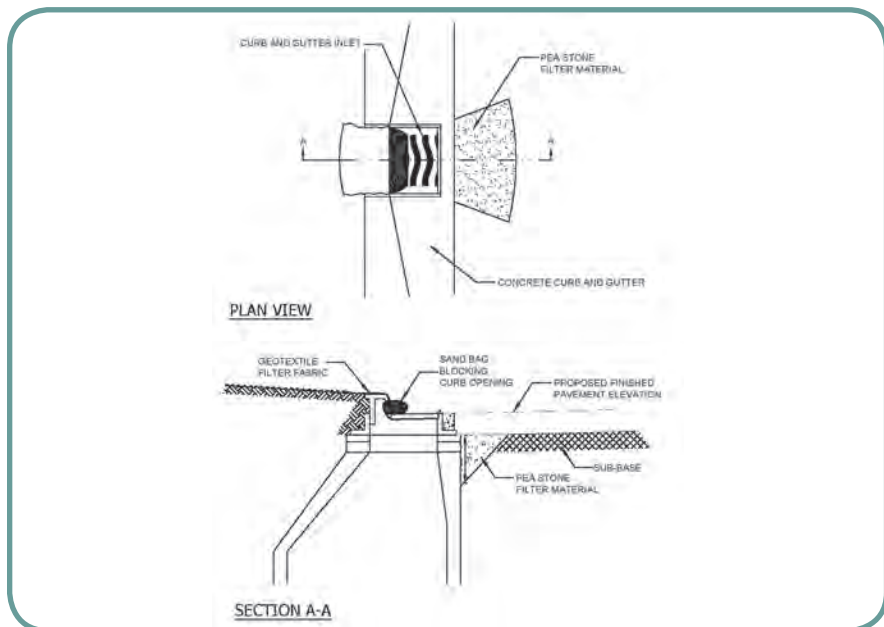

Figure 4-7 Curb and Gutter Inlet Filter, Before Paving

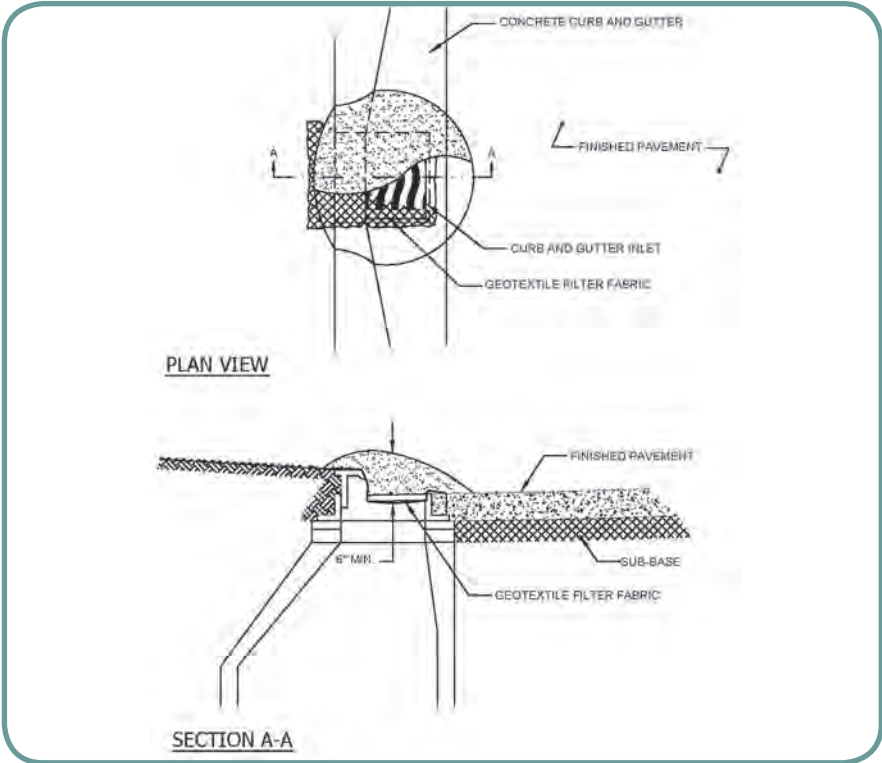

Figure 4-8 Curb and Gutter Inlet Filter, After Paving

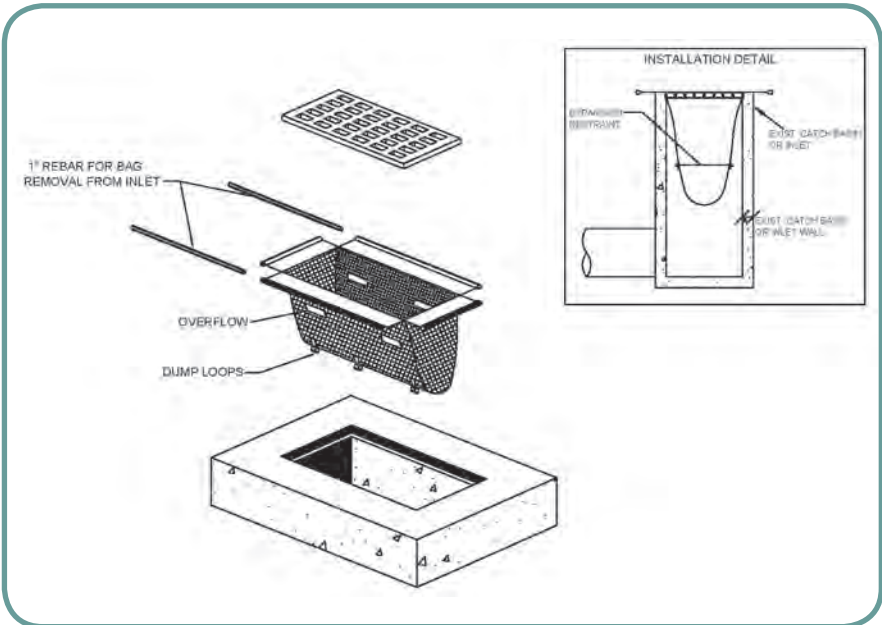

Figure 4-9 Bag and Frame Inlet Filter



Good application of an inlet grate wrapped with a geotextile.



Good application of silt fence to protect an area inlet. Use wire fence backing to reinforce frame, or diagonal bracing across top of stakes. Make sure the fence is trenched in to prevent bypasses or undercutting.



The inlet at the top of the picture is protected with a traditional geotextile fabric. The inlet at the bottom is protected with an inlet filter bag.

This is a good example of the proper application of a gravel filter on a curb inlet.



Straw makes good mulch but it is not suited for inlet protection.



Outlet Pipe Riprap Protection

Riprap installed at culvert outlets can protect the stream bed and channel from erosion. The size of the riprap is based on the shear force anticipated during high flow conditions.

Riprap installation, inspection, and maintenance for outlet protection are discussed in Chapter 3.

Table 4-1 provides general guidance for sizing rock and **energy dissipaters** for various sized pipes. Outlets that **discharge** high flows must follow the maximum suggested sizing criteria. Figure 4-10 shows typical riprap installation at an outlet pipe.

Table 4-1 Sizing Riprap Energy Dissipaters for Outlets

Culvert Size (in)	Avg. Rock Dia. (in)	Apron Width* (ft)	Apron Length** (ft)	Apron Length*** (ft)
8	3	2-3	3-5	5-7
12	5	3-4	4-6	8-12
18	8	4-6	6-8	12-18
24	10	6-8	8-12	18-22
30	12	8-10	12-14	22-28
36	14	10-12	14-16	28-32
42	16	12-14	16-18	32-38
48	20	14-16	18-25	38-44

- * Apron width at the narrow end (pipe or channel outlet)
- ** Apron length for slow-flow (no pressure head) culverts
- *** Apron length for high flow (pressure head) culverts

The presented information is for general use only. Riprap protection should be designed by a qualified professional.

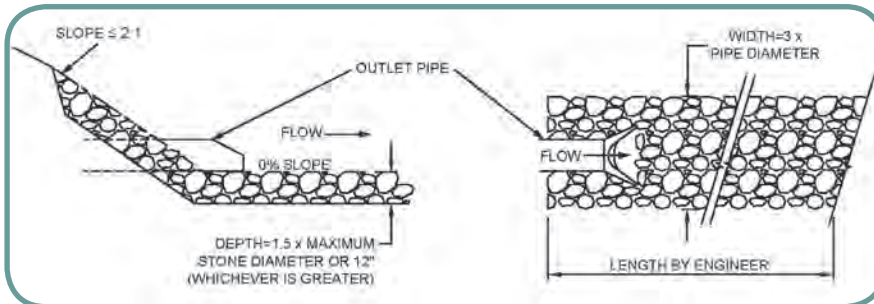

Figure 4-10 Riprap Installation, Pipe Outlet Application



This photo shows an improperly sized and constructed energy dissipater.

Detention Basin Outlet Filter

Detention basin outlet structures are designed to allow the sediment and solids to settle out. This results in cleaner stormwater exiting the basin. The outlet structure contains small holes that are covered by a layer of stone that filters out sediment and allows stormwater to be released at a controlled rate.

General Installation

- ❑ After excavating the detention basin, install the outlet, the corrugated metal pipe (CMP) control structure, and the primary control structure. Ensure that the outlet holes in the CMP control structure are level with the bottom of the basin.
- ❑ Install filter fabric where the stone will be placed.
- ❑ Backfill the outlet structure with 3-inch washed stone, free of sediment and debris.
- ❑ Place a layer of MDOT 6A stone over the 3-inch washed stone.
- ❑ Install riprap outlet protection for the outlet pipe flow.
- ❑ Stabilize the soil within the detention basin and earthen overflow control structure before the basin is put into operation.

Special Considerations

- ❑ While the vegetation is getting established in the detention basin, it is imperative to keep muddy water from washing into the stone surrounding the outlet structure.
- ❑ During large storm events the velocity of the flow passing out of the earthen secondary overflow structure and down the side slope can be very high. Make sure that the vegetation is well established and that the sod is properly anchored.

Common Mistakes

- ❑ Use of the detention basin before the vegetation is well established. This can lead to clogging of the stone and orifices in the CMP outlet structure.
- ❑ Orifices in the CMP outlet structure are not set at the proper elevation. Orifices left too high prevent the basin from properly draining and inhibit the growth of vegetation.

Inspection and Maintenance

- ❑ Inspect the structure to ensure that the orifices are not clogged.
- ❑ Inspect the stone to ensure the void spaces are not clogged with sediment. Clogged stone must be removed and washed before reinstalling.
- ❑ Inspect the exposed soil and slopes of the detention basin. If rills or gullies have formed, repair immediately and reseed if necessary.
- ❑ Inspect the riprap at the outlet. If there are signs of erosion or if the geotextile fabric is visible, repair immediately.

Tips

- ❑ Properly secure the edges of the filter fabric to prevent water from flowing underneath the fabric.
- ❑ The detention basin must not be put into operation until vegetation is established.



Insufficient soil compaction led to a slope failure on the bank of the detention basin. The CMP outlet structure (pictured in the foreground) is missing a bar grate cover.

The orifices in this outlet control are set too high to promote complete drainage of the detention basin. The wet conditions on the basin floor inhibit growth of vegetation.



PLAN VIEW

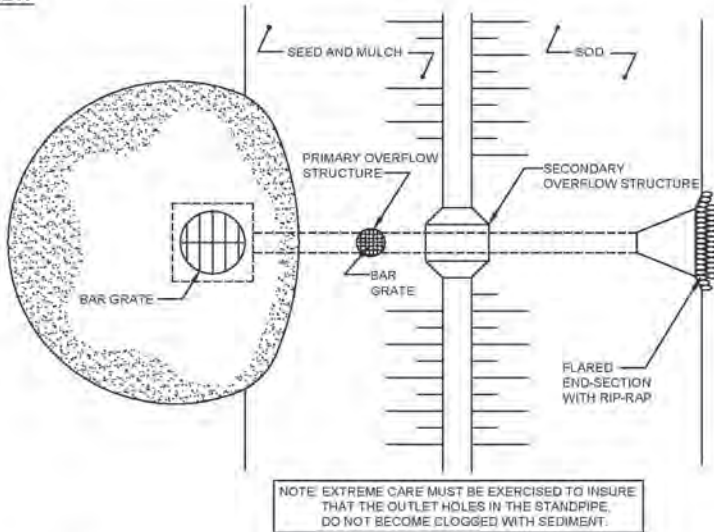

PROFILE VIEW

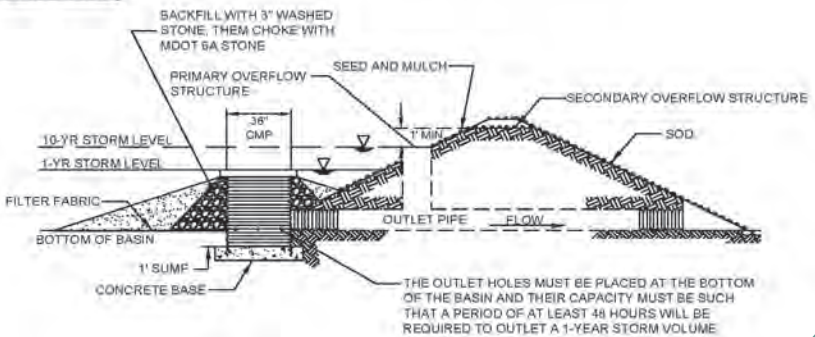

Figure 4-11 Detention Basin Outlet

Chapter 5 Sediment Traps, Basins, and Dewatering

Sediment Traps and Basins 58
Pump Filter Bags..... 62



Small, temporary sediment traps intercept and detain construction site runoff so soil particles can settle out. Designing traps and basins with long flow paths between the inlet and outlet also helps to increase sediment removal efficiency by extending the detention time. Where space restrictions prevent long basin designs, barriers placed in the basin can lengthen detention times by creating a serpentine flow path between the inlet and outlet. This photo shows an example of a sediment trap in a drainage ditch with a check dam.

SEDIMENT TRAPS, BASINS, AND DEWATERING

Sediment traps and **basins** are small impoundments that allow sediment to settle out of stormwater runoff. Sediment traps are typically located in ditches and may be used with check dams for improved efficiency.

Sometimes the only way to remove water from a low area is to pump it. When the water contains suspended sediment it must be filtered before it is discharged offsite.

Sediment Traps and Basins

The purpose of a sediment trap or basin is to provide an area where sediment-laden runoff is intercepted and allowed to pool, so that sediment will settle out. Sediment traps and basins are installed in natural drainage areas before excavation or fill work begins. Do not depend on sediment traps and basins alone to control sediment loss from the construction site. To prevent the overloading of sediment traps and basins, other uphill controls are needed on bare areas, slopes, and in ditches and channels.

Containment for the pooling area can be an excavated hole or a berm made of earth or stone. Straw bales and silt fencing are not approved for use as containment structures.

General Installation

- Sediment traps and basins shall be installed before any land disturbance takes place in the drainage area.
- Construct the sediment traps and basins on the downhill side of the bare soil areas where flows converge.
- Sediment traps are constructed 3-feet deep, with a 3-foot-long flat bottom and with side slopes no steeper than 1H:1V.
- Sediment basins are constructed with a depth double the cross sectional area of the ditch leading to the basin and an overall length equal to approximately 4 times the width of the ditch. Side slopes shall be no steeper than 2H:1V.
- The width of a sediment trap and basin should be sufficient to capture all of the flow without constricting the ditch width.

- ❑ Outlets for sediment traps and basins shall be at least 1-foot high, underlain with geotextile fabric and armored with riprap.
- ❑ Basin should be stabilized prior to being placed into operation.

Special Considerations

- ❑ Do not install sediment traps and basins in waters of the state.
- ❑ Sediment traps should have a maximum drainage area of 5 acres.
- ❑ Sediment basins should have a maximum drainage area of 10 acres. Sediment basins collecting more than 10 acres of drainage typically function as stormwater treatment ponds after construction is complete. If this is the case, agreements are required for long-term sediment removal and general maintenance.
- ❑ PAMs may be used in conjunction with sediment traps and basins to assist in the settlement of sediment.

Common Mistakes

- ❑ Placing sediment traps and basins into operation before they are stabilized.
- ❑ Failing to monitor and remove accumulated sediment.

Inspection and Maintenance

- ❑ Inspect inlets, berms, spillway, and outlet areas for erosion after each rain event exceeding 1/2 inch. Repair and reseed eroded areas as needed.
- ❑ Repair any rills or gullies that form and any upslope areas that contribute large volumes of sediment.
- ❑ If check dams are used, ensure they are being maintained properly.
- ❑ Remove sediment when the storage volume has been reduced by half.

Tips

- ❑ Check dams may be used in the outlet ditch to improve the sediment removal efficiency.
- ❑ Ensure that the pooled water does not flood buildings, roadways, or other structures.

This is a good example of a sediment trap and check dam constructed in a ditch.



This sediment trap is not properly constructed. It is not deep enough, wide enough, or long enough. The lack of a vegetated buffer surrounding the waterway is also a problem.



This sediment trap is full of sediment. It should have been cleaned out when the initial storage volume was reduced by half.



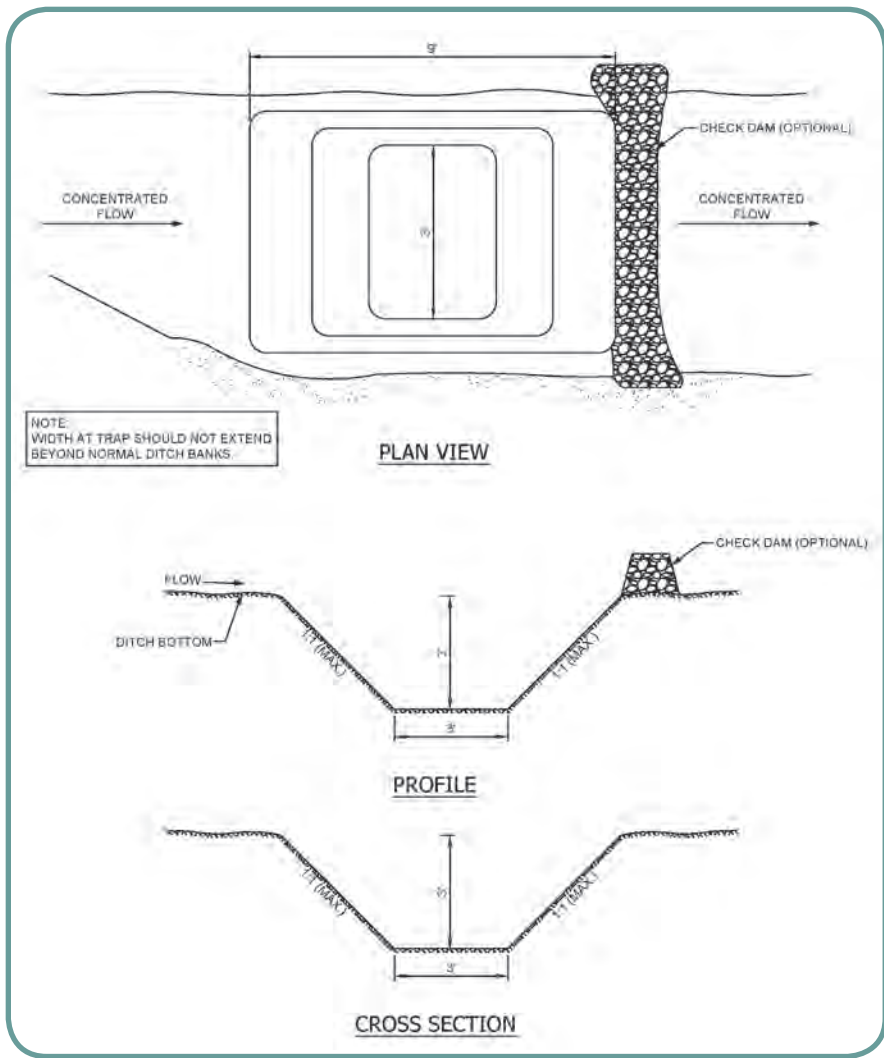

Figure 5-1 Sediment Trap

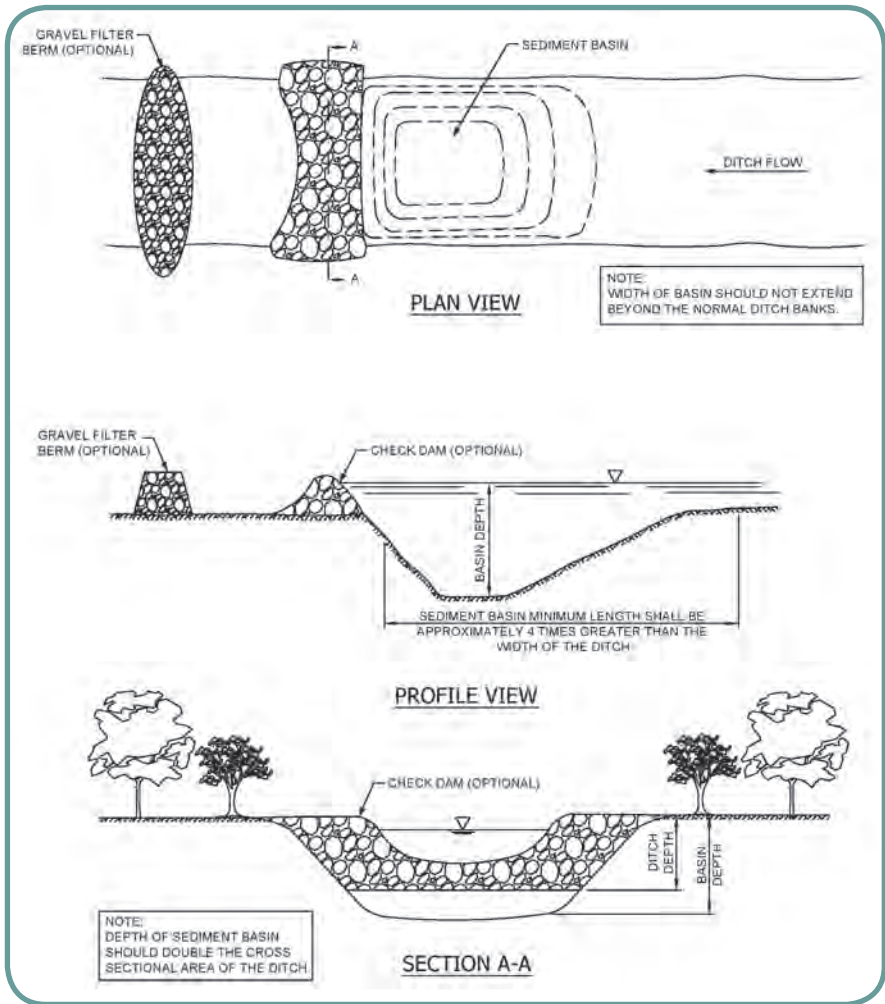

Figure 5-2 Sediment Basin

Pump Filter Bags

Dewatering is the pumping of stormwater or groundwater from excavation pits or trenches. The sediment-laden water must be pumped to a dewatering structure for sediment removal before it is discharged offsite. Pump discharge bags are used to filter sediment-laden water during dewatering operations.

General Installation

- ❑ The **filter bag** should be properly sized based on the flow rate, with a minimum size of 250 square feet. Multiple filter bags can be used if necessary.

- ❑ Install the filter bag on level, stable ground in a well-vegetated area or on gravel.
- ❑ Unfold the filter bag and place lifting straps under it to assist with removing the bag in the future.
- ❑ Connect the pump hose to the discharge bag. Secure the hose with hose clamps and check the connection for leaks.

Special Considerations

- ❑ Dissipate energy at the outlet to prevent scouring.
- ❑ Do not pump sediment-laden water directly to lakes, streams, county drains, storm drains, wetlands, or other environmentally sensitive areas.
- ❑ In some instances the use of PAMs may be used to improve the removal of sediment from the discharged water.

Common Mistakes

- ❑ Failing to check the filter bags for leaks or monitoring how much sediment is being captured.
- ❑ Not properly securing the discharge bag to the hose.

Inspection and Maintenance

- ❑ Follow all manufacturer maintenance requirements.
- ❑ Verify that the filter bag is filtering sediment.
- ❑ Inspect filter bag for wear, holes, or tears during pumping. If the bag is damaged, replace it immediately.
- ❑ Replace the filter bag when it is 1/2 full of sediment, if the bag appears damaged, or if it fails to discharge at a practical rate.
- ❑ Accumulated sediment may be spread out on site and stabilized, or disposed of off-site.
- ❑ Properly dispose of the bags. Bags cannot be reused.

Tips

- ❑ Direct discharges into waterways from dewatering operations are prohibited.

- ❑ Discharges into sanitary sewers from dewatering operations require permission from the wastewater treatment plant owner.
- ❑ Silt fences, sediment traps and/or basins, and PAMs can be used in addition to a filter bag for added water quality protection.

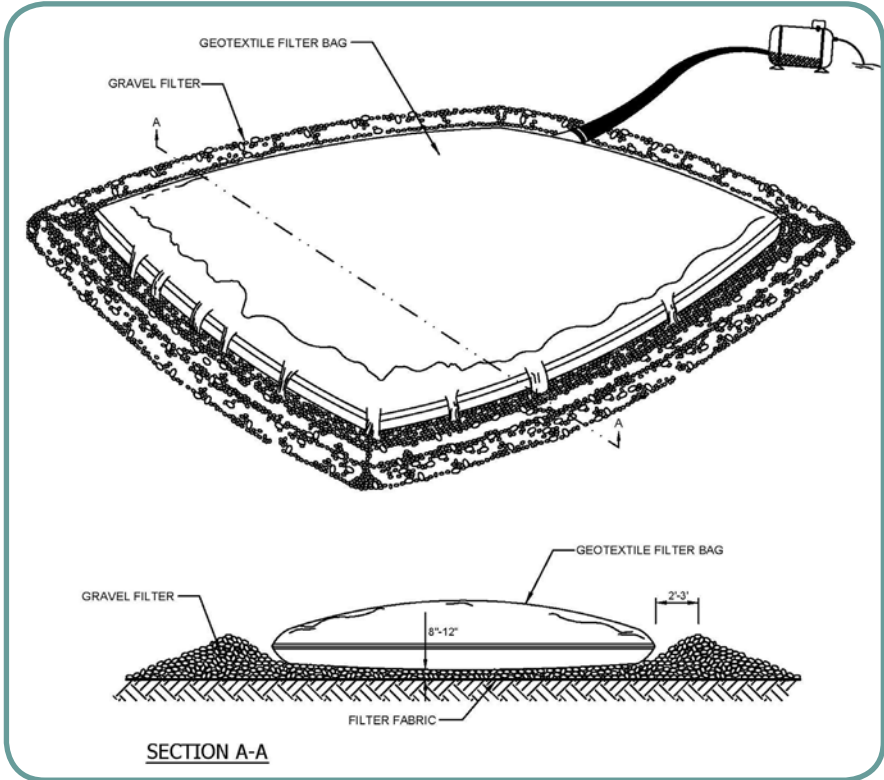

Figure 5-3 Pump Filter Bag

This photo illustrates the proper installation of a pump filter bag on a level, stable site with a gravel base.





This is an example of a filter bag in service. A stable and level bed of gravel should be used instead of a plywood base.



Too much sediment split this filter bag. Bags should not be filled more than 1/2 full of sediment.



Chapter 6 Stream and Wetland Protection

Permits	68
Stream Crossings	68
Vegetated Buffers	68
Turbidity Barriers	70



Projects near streams and wetlands must incorporate a number of soil erosion control measures to protect the sensitive areas. Particular care should be taken when developing the soil erosion control plan and the appropriate permits must be obtained before starting construction.

STREAM AND WETLAND PROTECTION

It is extremely important to be aware of any streams or wetlands that may be on or near a construction site. Disturb only the area necessary, leaving a vegetated buffer between the stream or wetland and the construction site.

Permits

Permits are required before any construction or **earth change** activities may take place in or near waterbodies. These areas include rivers, streams, creeks, lakes, ponds, wetlands, and floodplains. The type of permit required will vary based on the site location. Please contact the MDEQ, U.S. Army Corps of Engineers, Macomb County, and the local municipality to determine which permits are required for the intended construction site.

Stream Crossings

A temporary stream crossing is used for construction vehicles to cross a watercourse. The construction of a temporary stream crossing requires a permit and must be designed by a professional engineer. A specific soil erosion control plan for the stream crossing is developed as part of the design and permit process.

Vegetated Buffers

Vegetated buffers protect waterways by filtering sediment from a construction site. They are used to reduce sheet flow velocities, which prevents rills and gullies from forming. Vegetated buffers are usually placed adjacent to waterbodies. All vegetated areas help to promote infiltration of stormwater, which is a key objective in preventing erosion and controlling sediment movement off of the construction site. Research has shown that a buffer of 100 feet or more is needed to protect water quality and aquatic habitat.

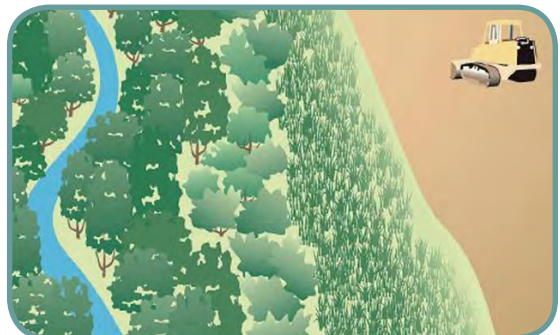

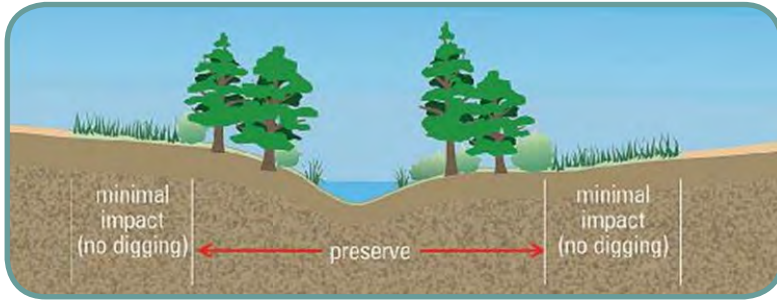

General Installation

- ❑ When used to reduce sheet flow velocities, vegetated buffers should be a minimum of 20-feet-wide and spaced 50 feet apart.
- ❑ When used to filter runoff entering a watercourse, the buffer width (distance from the edge of disturbed ground to the edge of the watercourse) needs to be at least 100 feet.
- ❑ If the buffer width is inadequate, a silt fence (or equivalent sediment filter for sheet flow) is required.
- ❑ If planting a new vegetated buffer area, refer to Chapter 2.

Special Considerations

- ❑ An optional diversion berm or diversion ditch may be placed to prevent water from running over the graded areas.

Common Mistakes

- ❑ Allowing the flow to become concentrated as it passes through a buffer. Buffers only work with sheet flow.
- ❑ Using buffer areas for material staging, parking, or pedestrian traffic.

Inspection and Maintenance

- ❑ Look for areas where buffers are being impacted by construction activities. Relocate construction activities away from buffers.
- ❑ Inspect buffers regularly to ensure that a healthy vegetative growth is maintained. Any bare spots or spots where sediment deposition could lead to the destruction of vegetation must be repaired.

Tips

- ❑ Use flagging or a protective fence to remind equipment operators and construction workers to stay away from the buffer.

- ❑ Use silt fences and buffers together to protect waterbodies and wetlands.
- ❑ Preserve existing vegetation within the buffer.

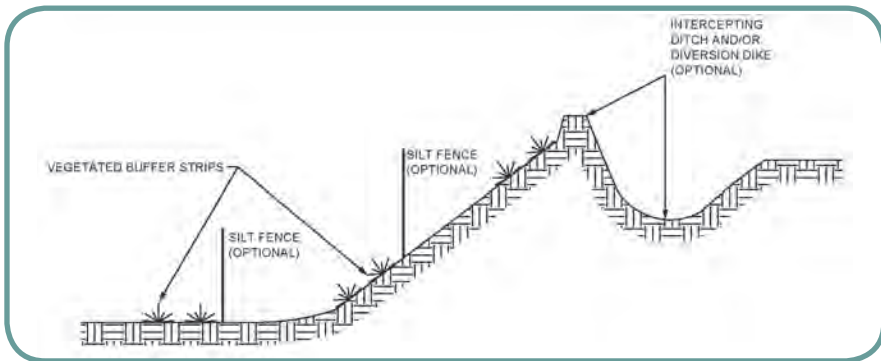

Figure 6-1 Vegetated Filter Strip

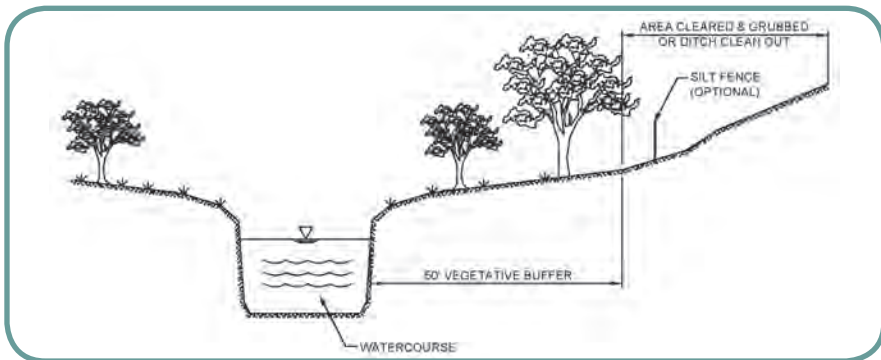

Figure 6-2 Vegetated Buffer

Turbidity Barriers

Turbidity barriers (also known as turbidity curtains, silt barriers, and silt curtains) are designed to contain and control the dispersion of sediment and silt in a water body.

Proper Installation

- ❑ Select the correct turbidity barrier for the application.
- ❑ Follow the manufacturer's installation procedures.
- ❑ Typically, the sections of the barrier should be rolled out on the ground and fastened together before deploying and anchoring the system in place.
- ❑ Turbidity barriers must be placed parallel to the channel flow.

Special Considerations

- ❑ The use of a turbidity barrier may require a permit.
- ❑ Care should be taken during the removal of the turbidity barrier to avoid or minimize re-suspension of the settled solids.

Inspection and Maintenance

- ❑ Replace worn or broken anchor lines.
- ❑ Maintain the integrity of the curtain by repairing leaking connectors and/or tears in the curtain fabric.
- ❑ Repair tears in the flotation pocket.
- ❑ Repair moderate tears in skirts on land.
- ❑ Keep one or two spare sections of curtain onsite for immediate replacement of unrepairable sections.

Tips

- ❑ The turbidity barriers can sink due to excessive accumulation of microorganisms, plants, algae, or animals on the fabric.
- ❑ Minimize the number of joints in the curtain; a minimum continuous space of 50 feet between joints is a good rule-of-thumb.
- ❑ The anchor lines should be attached to the flotation device, not to the bottom of the curtain.

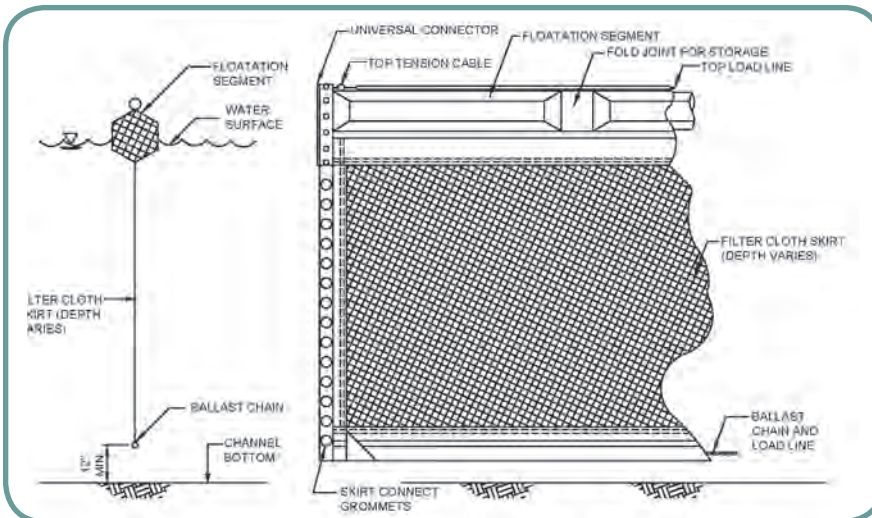
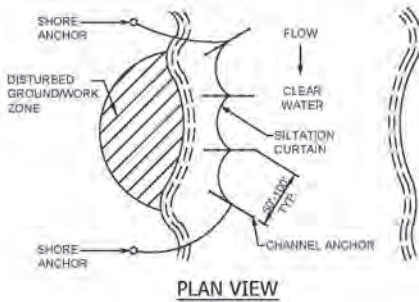

Figure 6-3 Turbidity Barrier

In this photo, a turbidity barrier is used with a cofferdam.



TYPICAL ANCHORING PLAN FOR SHORELINER/RIVER EDGE WORK



TYPICAL ANCHORING PLAN FOR MID CHANNEL WORK

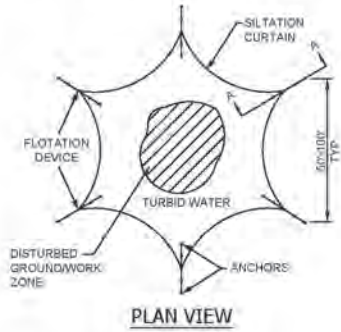

TYPICAL ANCHORING SECTION

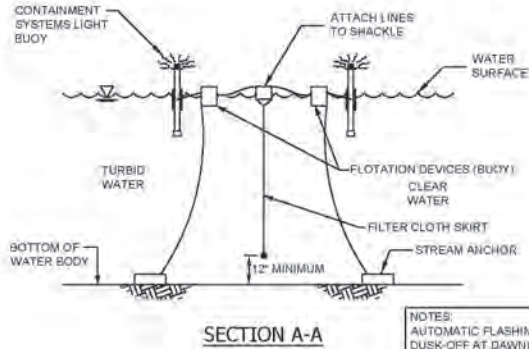

NOTES:
AUTOMATIC FLASHING LIGHT BUOY (ON AT DUSK-OFF AT DAWN) 100 FT. ON CENTER SHALL BE USED IN NAVIGABLE CHANNELS ONLY.

Figure 6-4 Turbidity Barrier Typical Anchoring Method

Chapter 7 Final Stabilization for Close-Out

After all proposed construction activity has been completed, the site must be stabilized. This section describes what needs to be done to close out a soil erosion and sediment control permit.

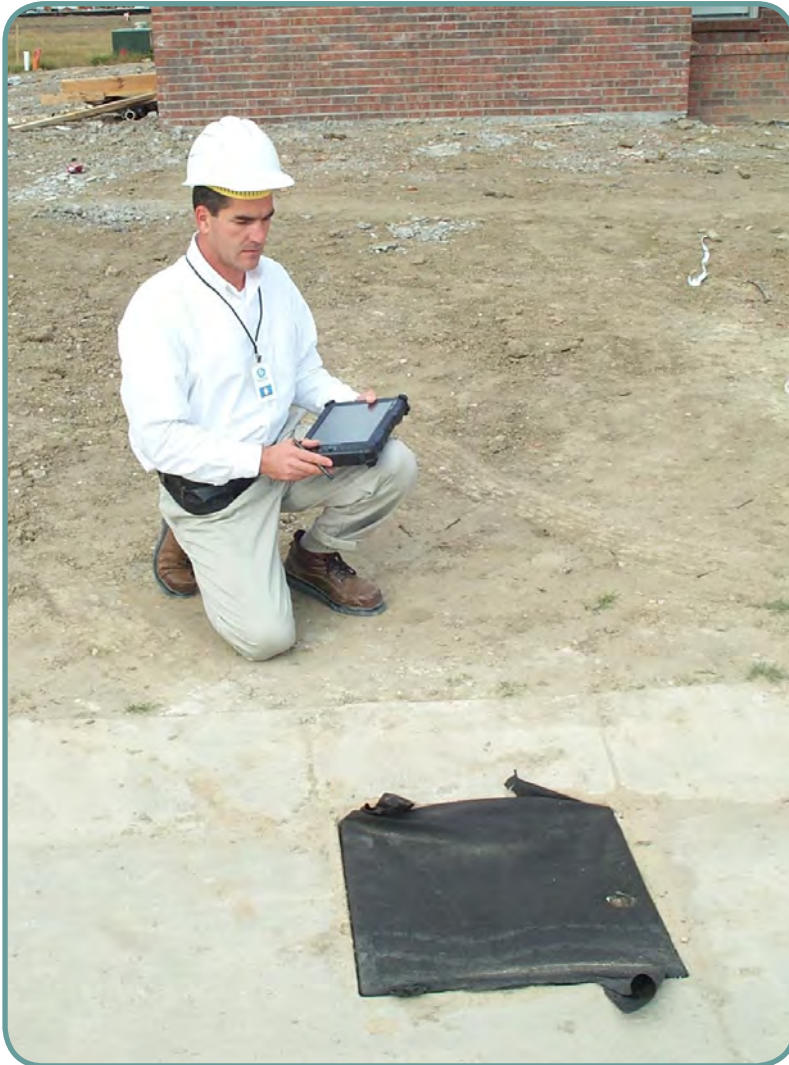

Close-Out

FINAL STABILIZATION FOR CLOSE-OUT

No site is closed out properly until 90% of each square foot has established vegetation. Vegetation must be at least 3 inches tall. Check seeded areas; reseed areas where vegetation is thin or absent.

- ❑ If the site is stabilized, remove silt fences and stakes. Rake and seed the area. Properly dispose of the accumulated sediment.
- ❑ Remove and properly dispose of the inlet filters.
- ❑ Culvert inlets should be stabilized, vegetated, and showing no visible gullies. Replace rock or soil that has been washed away by runoff or upstream flows. Brush or other debris that could clog inlets must be removed.
- ❑ Check ditches and channels to make sure banks and ditch bottoms are well vegetated. Reseed bare areas and replace rock that has become dislodged.
- ❑ Check areas where erosion control blankets or matting was installed. Cut away and remove all loose exposed material, especially in areas where walking or mowing will occur. Reseed all bare soil areas to achieve 90% cover.
- ❑ Replace rock washouts near culvert and channel outlets. Fill, grade and seed or riprap eroded areas around inlets and outlets. Make sure downstream ditches and channels are fully vegetated. Fill and seed any gullies along the banks or other slopes.
- ❑ Fill in, grade, and seed all temporary sediment traps and basins that have been removed. Double the seeding rate where runoff flows might converge or high velocity flows are expected.
- ❑ Remove accumulated sediment from the curb and gutter area and sweep adjacent roads.

Make sure all subcontractors have repaired their work areas prior to final closeout. Conduct a final inspection of all work areas, vegetation, stormwater flow structures, and downstream receiving waters to make sure no visible gullies or sediment movement is evident. Notify site owner or manager after all temporary erosion and sediment controls have been removed and stabilization has been completed. If the site is 5 acres or larger and covered under a Michigan Department of Environmental Quality (MDEQ) Construction Stormwater Permit, submit a Notice of Termination to the State of Michigan.

GLOSSARY

Acronyms

CMP Corrugated Metal Pipe

MDEQ Michigan Department of Environmental Quality

MDOT Michigan Department of Transportation

MSDS Material Safety Data Sheet

PAM Polyacrylamide

SESC Soil Erosion and Sediment Control

RYCB Rear Yard Catch Basin

TRM Turf reinforcement mat

Glossary

Accelerated Erosion – Erosion much more rapid than normal, primarily as a result of the influence of the activities of man.

Backfill – The material used to refill a ditch or other excavation, or the process of doing so.

Channel – A natural stream that conveys water; a ditch or channel excavated for the flow of water.

Check Dam – A device that is constructed of stone, crushed concrete, or gravel bags that are placed in a channel or ditch. They slow down the water and aid in the settlement of suspended solids.

Compaction – The process by which soils are rearranged to decrease void space and bring them into closer contact with one another, thereby increasing the weight of solid material per cubic foot.

Concentrated Flow – Runoff that accumulates or converges into well-defined channels.

Construction Activities – Earth-disturbing activities, such as the clearing, grading, and excavation of land.

Contour – An imaginary line on the surface of the earth connecting points of the same elevation.

Dewatering – The act of removing groundwater, surface water, or stormwater from a site to allow construction to be done “in the dry.”

Discharge – When used without qualification, means the discharge of a pollutant.

Disking – Tilling the soil with a series of heavy duty steel disks. Disk implements generally cause substantial inversion of soil.

Disturbed Area – Portion of any site that has been altered from existing conditions, including but not limited to the following: providing access to a site; clearing of vegetation, grading, earth moving; providing utilities and other services such as parking facilities, stormwater management and erosion control systems; potable water and wastewater systems; altering land forms; or construction or demolition of a structure on the land.

Diversion Berm – A long mounded “collar” of compacted soil uphill from an excavated area. It is designed to intercept overland runoff and direct it around the construction site.

Diversion Ditch – A ditch that is designed to intercept and divert upland runoff around an area of bare soils.

Earth Change – Actions taken to alter the existing vegetation and/or underlying soil of a site, such as clearing, grading, site preparation (e.g., excavating, cutting, and filling), soil compaction, and movement and stockpiling of top soils.

Energy Dissipater – A device used to reduce the energy of flowing water.

Erosion - Detachment and movement of soil or rock fragments by water, wind, ice, or gravity.

Erosion and Sedimentation Control Plan – A plan for the control of erosion and sediment resulting from a land-disturbing activity.

Erosion Control Blankets – Prefabricated blankets that are made with straw, wood, or coconut fibers. They provide protection against erosion and facilitate plant growth.

Erosive – Having sufficient velocity to cause erosion; refers to wind or water.

Excavation – A cavity or hole in the land surface that is caused by the cutting, digging, or scooping and removal of soil, rock, or other material.

Existing Grade – The vertical location of the existing ground surface prior to cutting or filling.

Exposed Soils – Soils that, as a result of earth change activities, are left open to the elements.

Fertilizer – Any organic or inorganic material of natural or synthetic origin that is added to a soil to supply elements essential to growth.

Filling – Any deposit or stockpiling of dirt, rocks, stumps, or other natural or man-made solid material.

Furrow – A narrow longitudinal channel or trench made by a plow or grader.

Geotextile – A term used to describe woven or nonwoven fabric materials used to reinforce or separate soil and other materials.

Gabion – Large galvanized steel baskets that are filled with rock or broken concrete. They may be used to construct retaining walls, or for shore and stream bank protection.

Grade – To finish the surface of a canal bed, roadbed, top of embankment, or bottom of excavation.

Grade Control Structure – A structure used to carry runoff from one level to another.

Grading – Any clearing, excavating, filling or other disturbance of the land.

Gully Erosion – The erosion process whereby water accumulates in narrow channels and, over short periods, removes the soil.

Hard Armor – Hard armor refers to a hardened surface such as concrete, rock, or geogrids, applied to a surface to prevent erosion.

Inlet filters – A filter that covers or is installed under a storm drain inlet. It is made of geotextile fabric and is used to filter sediment out of stormwater.

J-hooks – J-hooks are curved sections of silt fence that will prevent the soil from bypassing the silt fence and create an area for sediment to pond.

Mulch – A material such as straw, compost, or wood bark that is applied to an area to cover the soil.

Mulch Anchoring Disk – A mulch anchoring disk tool is a tractor-drawn implement designed to punch and anchor mulch into the top 2 to 8 inches of soil. A set of disk harrows can be used for this purpose if the disks are straightened (not angled) so they cut the straw into the soil.

Natural Buffer – An area of undisturbed natural cover surrounding surface waters within which construction activities are restricted. Natural cover includes the vegetation, exposed rock, or barren ground that exists prior to commencement of earth change activities.

Outlet – The point of discharge of a stormwater drainage system to a receiving waterbody. For example, the location where a culvert or storm sewer discharges into a stream.

Plowing – A tillage operation which is performed to loosen and shatter soil with partial or complete soil inversion.

Polyacrylamide (PAM) – Polymer-based materials used to facilitate erosion control by binding soil particles. Only anionic PAMs are allowed for use on construction sites in the State of Michigan.

Pump Filter Bags – A geotextile bag that is placed on the end of a pump discharge hose and acts as a filter to remove sediment from the pumped water.

Rain Splash – The spattering of small soil particles caused by the impact of raindrops on wet soils.

Rill Erosion – An erosion process in which numerous small channels, only several inches deep, occur mainly on recently disturbed and exposed soils.

Ripping – The tilling of soil for the purpose of loosening it and/or improving water movement and root penetration.

Riprap – Broken rocks, cobbles, or boulders placed on earth surfaces, such as the face of a dam or the bank of a stream for protection against the action of water.

Scarify – A grading practice where a drag box, cultivator, or a tracked construction vehicle is used to roughen the surface or the soil on a slope.

Sediment – Solid material, both mineral and organic, that is in suspension, is being transported, or has been moved from its site of origin by air, water, gravity, or ice as a product of erosion.

Sediment Basin – A basin that is commonly used on a construction site to trap sand and silt-sized sediment carried by stormwater runoff.

Sediment Trap – Small impoundments in ditches that allow sediment to settle out of construction runoff. Sediment traps are essentially small sediment basins.

Seedbed – The soil prepared by natural or artificial means to promote the germination of seed and the growth of seedlings.

Sheet Erosion – The removal of a fairly uniform layer of soil from the land surface by runoff water.

Sheet Flow – Overland flow of water taking the form of a thin, continuous film over relatively smooth soil or rock surfaces and not concentrated into channels larger than rills.

Silt Fence – A temporary sediment control device used on construction sites to trap sediment and keep it from entering nearby water bodies.

Soil – The unconsolidated mineral and organic material on the immediate surface of the Earth that serves as a natural medium for the growth of land plants.

Spoil – Soil or rock material excavated from a canal, ditch, basin, or similar construction.

Stabilization – The use of vegetative and/or non-vegetative cover to prevent erosion and sediment loss in areas exposed through the construction process.

Stormwater – Stormwater runoff, snow melt runoff, and surface runoff and drainage.

Storm Drain Inlet – A structure placed below grade to conduct water used to collect stormwater runoff for conveyance purposes.

Surface Roughening – A technique for creating horizontal depressions, furrows, or other roughened surfaces on bare ground using tracked or other equipment.

Tackifier – A bonding or adhesive agent that is used for hydraulic seeding or straw mulch tacking.

Temporary Stabilization – A condition where exposed soils or disturbed areas are provided a temporary vegetative and/or non-vegetative protective cover to prevent erosion and sediment loss. Temporary stabilization may include temporary seeding, geotextiles, mulches, and other techniques to reduce or eliminate erosion until either final stabilization can be achieved or until further construction activities take place to re-disturb this area.

Tilling – The mechanical preparation of the soil to facilitate the growth of vegetation.

Topsoil – Earthy material used as top-dressing for house lots, grounds for large buildings, gardens, road cuts, or similar areas. It has favorable characteristics for production of desired kinds of vegetation or can be made favorable.

Turbidity – A condition of water quality characterized by the presence of suspended solids and/or organic material.

Turbidity Barrier – A floating barrier designed to contain and control the dispersion of suspended solids in a water body. The purpose of the barrier is to provide sediment containment when a construction practice is occurring in or directly adjacent to a waterbody.

Turf Reinforcement Mat (TRM) – An erosion control product made of synthetic materials and laid out as a mat covering a slope or channel. TRMs provide immediate erosion protection and enhance vegetation establishment.

Upland – The dry land area above and “landward” of the ordinary high water mark.

Vegetative Buffer – An undeveloped area directly adjacent to a body of water.

Wattles – Fiber rolls made of coconut fiber, straw, wood shavings, or other materials. They are used to slow, filter, and spread overland flows. They also help prevent erosion and minimize rill and gully development.

IMPORTANT NUMBERS

Armada Township

23121 East Main Street
Armada, MI 48005
586.784.5200
www.armadatwp.org

Village of Armada

74274 Burk Street
Armada, MI 48005
586.784.9151
www.villageofarmada.org

Bruce Township

223 East Gates
Romeo, MI 48065
586.752.4585
www.brucetwp.org

City of Centerline

7070 10 Mile Road
Centerline, MI 48015
586.757.6800
www.centerline.gov

Chesterfield Township

47275 Sugarbush Road
Chesterfield MI, 48047
586.949.0400
www.chesterfieldtwp.org

Clinton Township

40700 Romeo Plank Road
Clinton Township, MI 48038
586.286.8000
www.clintontownship-mi.gov

City of Eastpointe

23200 Gratiot Avenue
Eastpointe, MI 48021
586.445.3661
www.cityofeastpointe.net

City of Fraser

33300 Garfield
Fraser, MI 48026
586.293.3100
www.micityoffraser.com

Harrison Township

38151 L'Anse Creuse
Harrison Township, MI 48045
586.466.1400
www.harrison-township.org

Lenox Township

63775 Gratiot Avenue
Lenox, MI 48050
586.727.2085
www.lenoxtwp.org

Macomb Township

54111 Broughton Road
Macomb, MI 48042
586.992.0710
www.macomb-mi.gov

City of Memphis

3595 Potter
Memphis, MI 48041
810.392.2385
www.memphismi.com

City of Mt. Clemens

One Crocker Boulevard
Mt. Clemens, MI 48043
586.469.6818
www.cityofmountclemens.com

City of New Baltimore

36535 Green Street
New Baltimore, MI 48047
586.725.2151
www.cityofnewbaltimore.org

Village of New Haven

57775 Main Street
New Haven, MI 48048
586.749.5301
www.villageofnewhaven.org

Ray Township

64255 Wolcott
Ray, MI 48096
586.749.5171
www.raytwp.org

City of Richmond

68225 Main Street
Richmond, MI 48062
586.727.7571
www.cityofrichmond.net

Richmond Township

34900 School Section Road
Richmond, MI 48062
586.727.8998
www.richmondtpw.org

Village of Romeo

121 West St. Clair
Romeo, MI 48065
586.752.3565
www.villageofromeo.org

City of Roseville

P.O. Box 290
29777 Gratiot
Roseville, MI 48066
586.445.5402
www.ci.roseville.mi.us

City of St. Clair Shores

27600 Jefferson Circle Drive
St. Clair Shores, MI 48081
586.445.5200
www.stclairshores.net

Shelby Township

52700 Van Dyke
Shelby Township, MI 48316
586.731.5100
www.shelbytwp.org

City of Sterling Heights

P.O. Box 8009
40555 Utica Road
Sterling Heights, MI 48311
586.446.2489
www.sterling-heights.net

City of Utica

7550 Auburn Road
Utica, MI 48317
586.739.1600
www.cityofutica.org

City of Warren

One City Square
Warren, MI 48093
586.574.4500
www.cityofwarren.org

Washington Township

57900 Vandyke
Washington, MI 48094
586.786.0010
www.miwashington.com



Macomb County Public Works Office

21777 Dunham

Clinton Township, MI 48036

586.469.5327

<http://publicworks.macombgov.org>



Macomb County Department of Roads

117 South Groesbeck

Mt. Clemens, MI 48043

586.463.8671

<http://roads.macombgov.org>

Macomb County Health Department

43525 Elizabeth Road

Mt. Clemens, MI 48043

586.469.5235

www.macombgov.org/publichealth

Michigan Department of Environmental Quality

Southeast Michigan District Office

27700 Donald Court

Warren, MI 48092

586.753.3700

www.michigan.gov/deq

